

RECTIFIER DIODES MODULE

AZD1080

Repetitive voltage up to **2800 V**
Mean forward current **1087 A**
Surge current **30,0 kA**

FINAL SPECIFICATION

Apr. 17 - Issue: 2

Symbol	Characteristic	Conditions	T _j [°C]	Value	Unit
BLOCKING					
V _{RRM}	Repetitive peak reverse voltage		150	2800	V
V _{RSM}	Non-repetitive peak reverse voltage		150	2900	V
I _{RRM}	Repetitive peak reverse current		150	75	mA
CONDUCTING					
I _{F(AV)}	Mean forward current	180° sin, 50 Hz, T _c =100°C, single side cooled		1087	A
I _{F(AV)}	Mean forward current	180° sin, 50 Hz, T _c =55°C, single side cooled		1767	A
I _{FSM}	Surge forward current	Sine wave, 10 ms without reverse voltage	150	30	kA
I ² t	I ² t			4500 x 10 ³	A ² s
V _{FM}	Forward voltage	Forward current = 1800 A	25	1,20	V
V _{F(TO)}	Threshold voltage		150	0,80	V
r _F	Forward slope resistance		150	0,110	mohm
SWITCHING					
t _{rr}	Reverse recovery time		150		µs
Q _{rr}	Reverse recovery charge				µC
I _{rr}	Peak reverse recovery current				A
MOUNTING					
R _{th(j-c)}	Thermal impedance, DC	Junction to case		42,0	°C/kW
R _{th(c-h)}	Thermal impedance	Case to heatsink		15,0	°C/kW
T _j	Operating junction temperature			-30 / 150	°C
V _{ins}	RMS insulation voltage	50Hz, circuit to base,all terminal shorted	25	4500	V
T	Mounting torque	Case to heatsink		4 to 6	Nm
		Busbars to terminals		12 to 18	Nm
	Mass			2800	g

ORDERING INFORMATION : AZD1080 S 28

standard specification VRRM/100

DISSIPATION CHARACTERISTICS

SQUARE WAVE

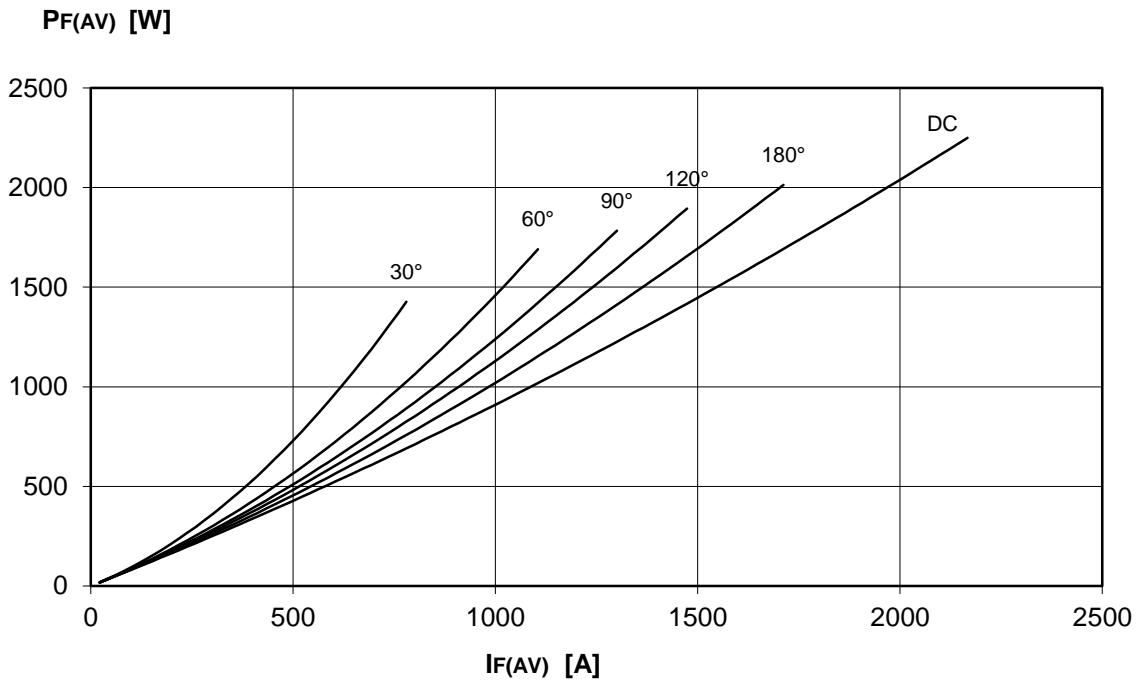
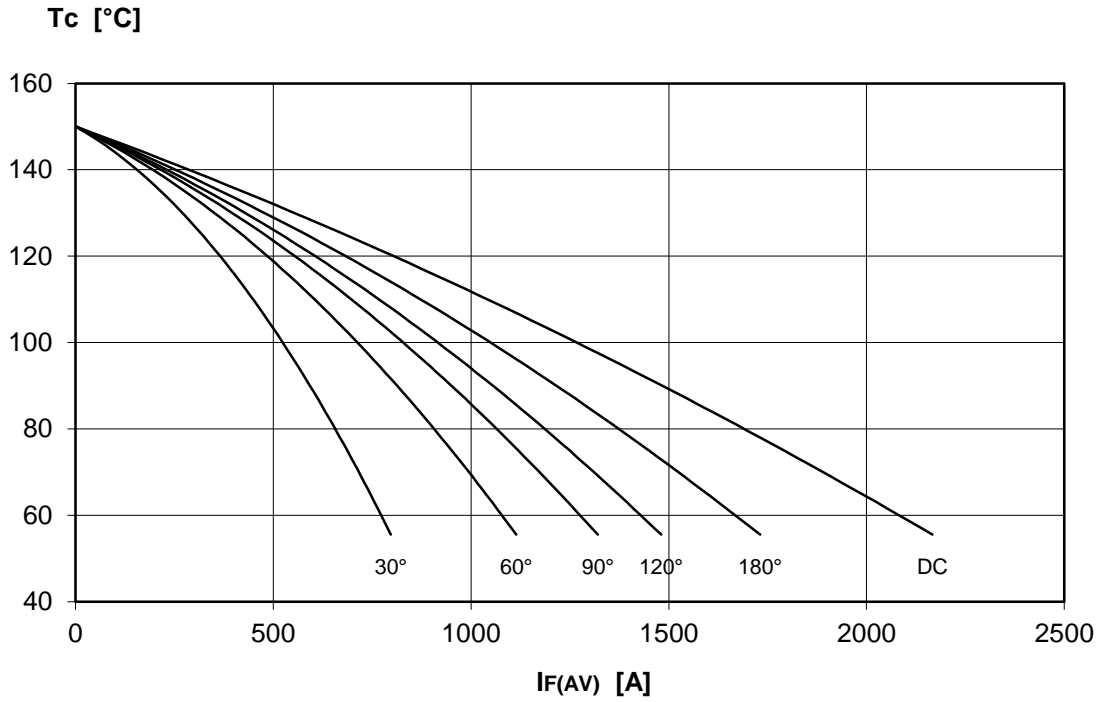

DISSIPATION CHARACTERISTICS

SINE WAVE

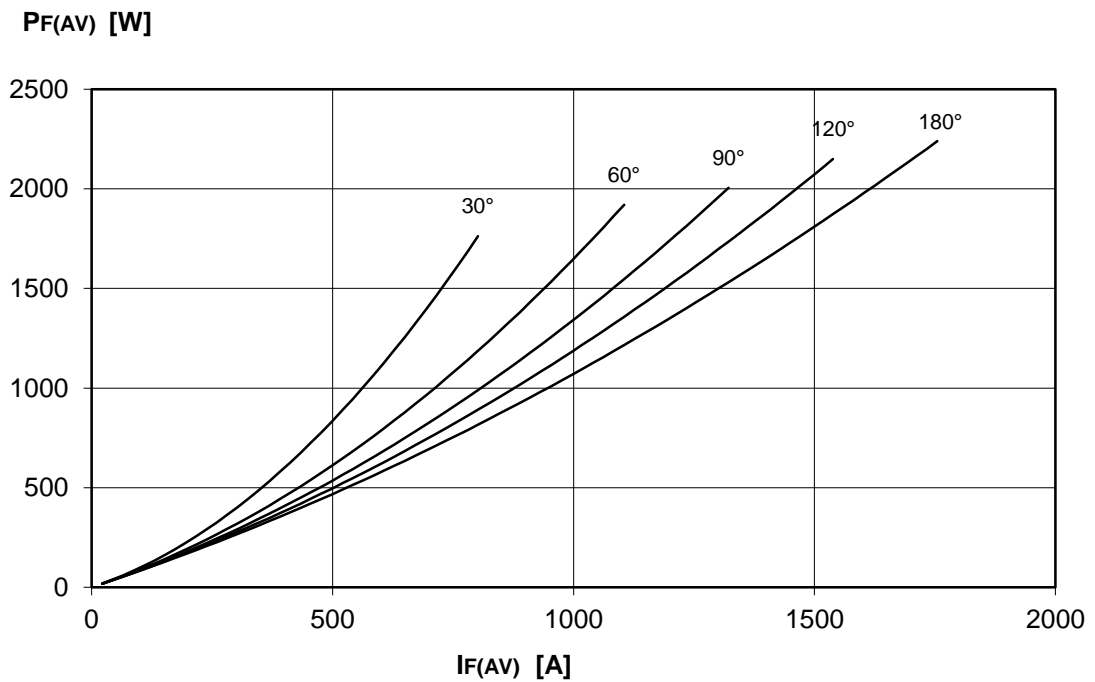
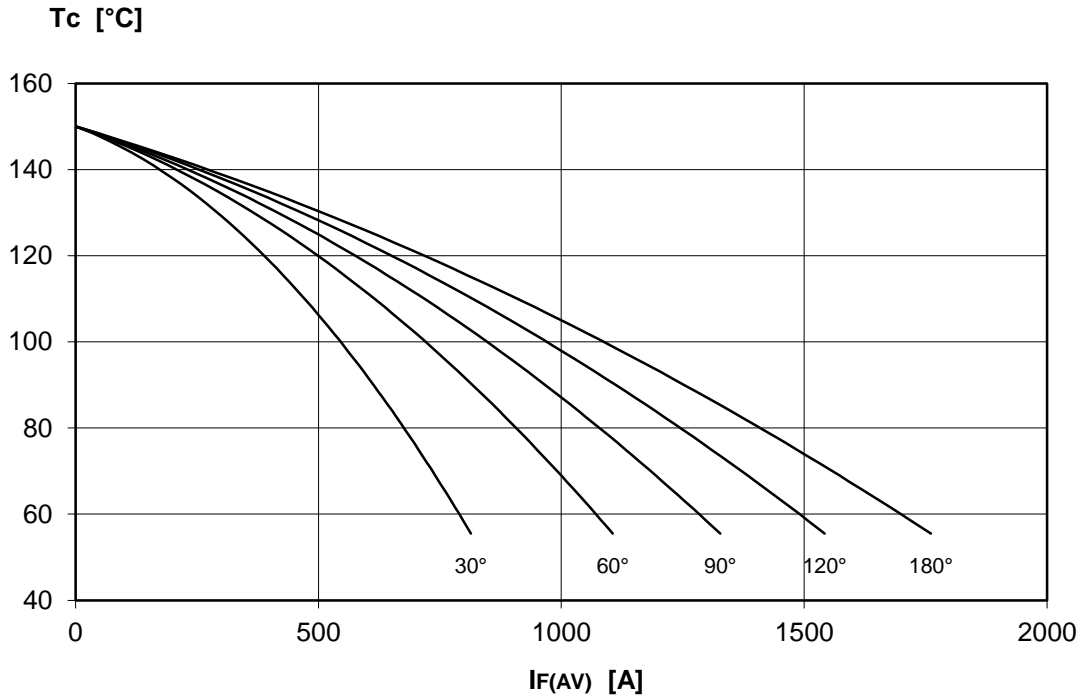

ON-STATE CHARACTERISTIC
T_j = 150 °C

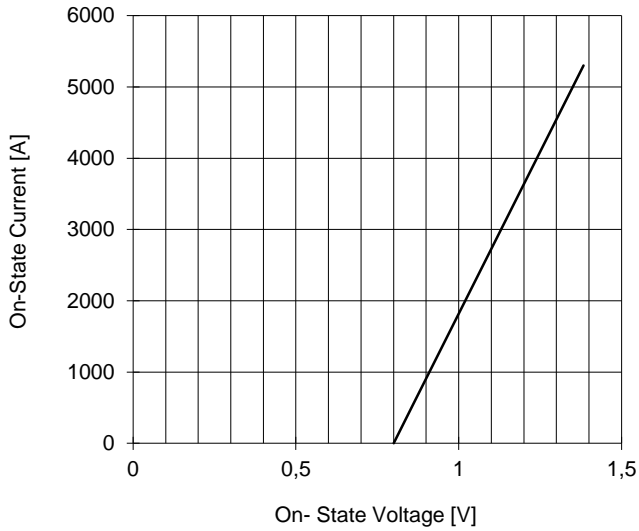

SURGE CHARACTERISTIC
T_j = 150 °C

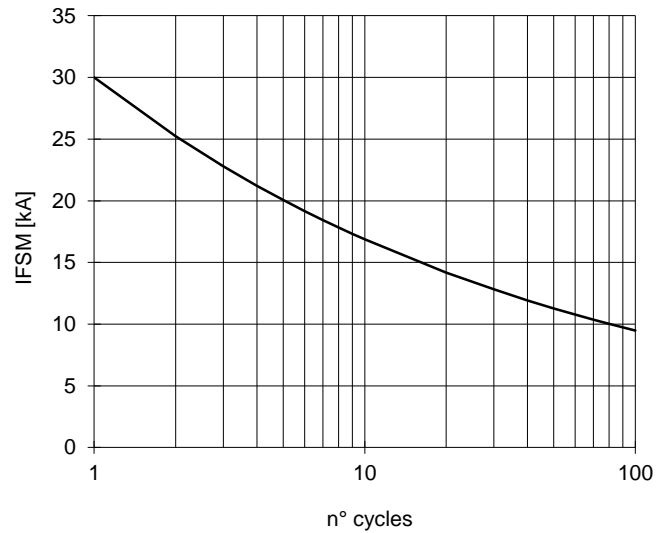

TRANSIENT THERMAL IMPEDANCE

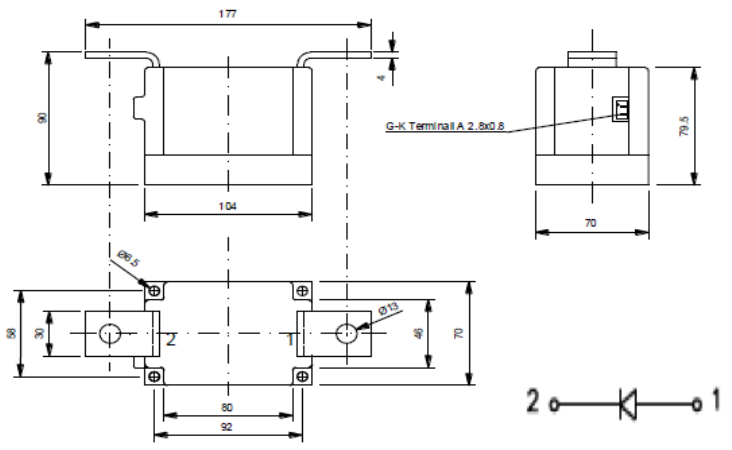
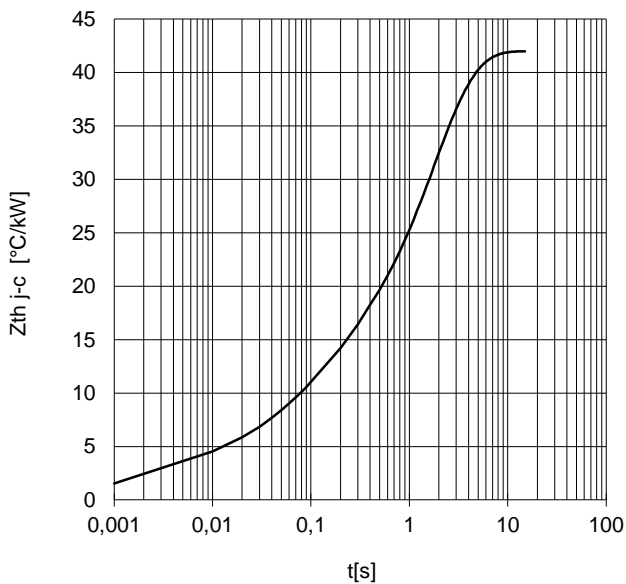

All the characteristics given in this data sheet are guaranteed only with uniform clamping force, cleaned and lubricated heatsink, surfaces with flatness < .03 mm and roughness < 2 μm.
 In the interest of product improvement POSEICO SpA reserves the right to change any data given in this data sheet at any time without previous notice.
 If not stated otherwise the maximum value of ratings (symbols over shaded background) and characteristics is reported.

Distributed by

