

PHASE CONTROL THYRISTOR

AT971

Repetitive voltage up to **4200 V**
Mean on-state current **3977 A**
Surge current **68. kA**

FINAL SPECIFICATION

Feb. 17 - Issue: 4

Symbol	Characteristic	Conditions	T _j [°C]	Value	Unit
BLOCKING					
V _{RRM}	Repetitive peak reverse voltage		125	4200	V
V _{RSM}	Non-repetitive peak reverse voltage		125	4300	V
V _{DRM}	Repetitive peak off-state voltage		125	4200	V
I _{RRM}	Repetitive peak reverse current	V=VRRM	125	300	mA
I _{DRM}	Repetitive peak off-state current	V=VDRM	125	300	mA
CONDUCTING					
I _{T(AV)}	Mean on-state current	180° sin, 50 Hz, Th=55°C, double side cooled		3977	A
I _{T(AV)}	Mean on-state current	180° sin, 50 Hz, Tc=85°C, double side cooled		3176	A
I _{TSM}	Surge on-state current	sine wave, 10 ms	125	68.0	kA
I ² t	I ² t	without reverse voltage		23120 x1E3	A²s
V _T	On-state voltage	On-state current = 7500 A	25	2.06	V
V _{T(TO)}	Threshold voltage		125	1.12	V
r _T	On-state slope resistance		125	0.125	mohm
SWITCHING					
di/dt	Critical rate of rise of on-state current, min.	From 67% VDRM, gate 10V 5ohm	125	200	A/μs
dv/dt	Critical rate of rise of off-state voltage, min.	Linear ramp up to 67% of VDRM	125	1000	V/μs
td	Gate controlled delay time, typical	VD=100V, gate source 10V, 10 ohm, tr=5 μs	25		μs
tq	Circuit commutated turn-off time, typical	dv/dt = 20 V/μs linear up to 75% VDRM		700	μs
Q _{RR}	Reverse recovery charge	di/dt=-20 A/μs, I= 2150 A	125		μC
I _{RR}	Peak reverse recovery current	VR= 50 V			A
I _H	Holding current, typical	VD=5V, gate open circuit	25	500	mA
I _L	Latching current, typical	VD=12V, tp=50μs	25	1500	mA
GATE					
V _{GT}	Gate trigger voltage	VD=12V	25	3.5	V
I _{GT}	Gate trigger current	VD=12V	25	250	mA
V _{GD}	Non-trigger gate voltage, min.	VD=67%VDRM	125	0.25	V
V _{FGM}	Peak gate voltage (forward)			10	V
I _{FGM}	Peak gate current			10	A
V _{RGM}	Peak gate voltage (reverse)			10	V
P _{GM}	Peak gate power dissipation	Pulse width 100 μs		150	W
P _G	Average gate power dissipation			3	W
MOUNTING					
R _{th(j-c)}	Thermal impedance, DC	Junction to case, double side cooled		6.0	°C/kW
R _{th(c-h)}	Thermal impedance	Case to heatsink, double side cooled		1.5	°C/kW
T _j	Operating junction temperature			-30 / 125	°C
F	Mounting force			80.0 / 100.0	kN
	Mass			3000	g

ORDERING INFORMATION : AT971 S 42

standard specification VDRM&VRRM/100

DISSIPATION CHARACTERISTICS

SQUARE WAVE

Th [°C]

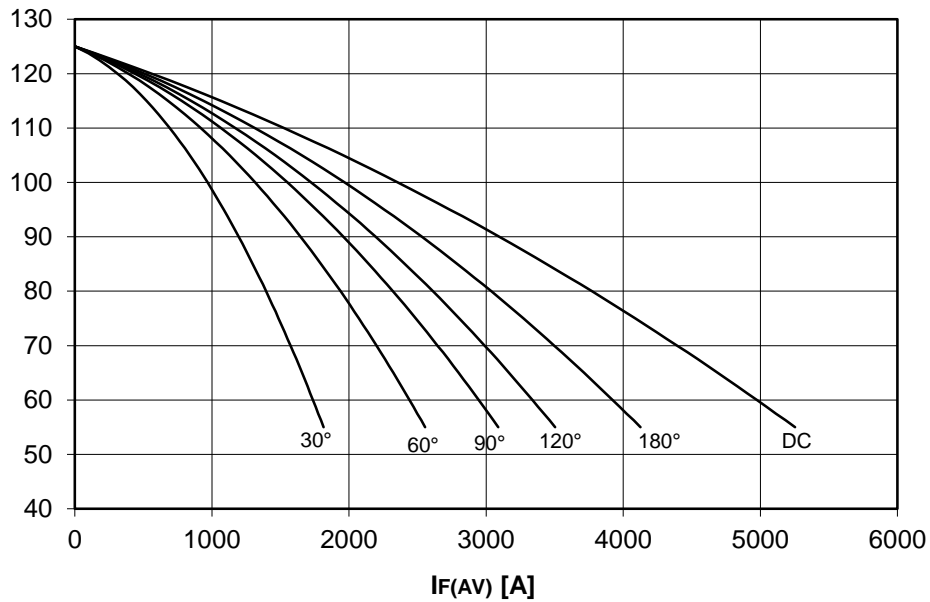

PF(AV) [W]

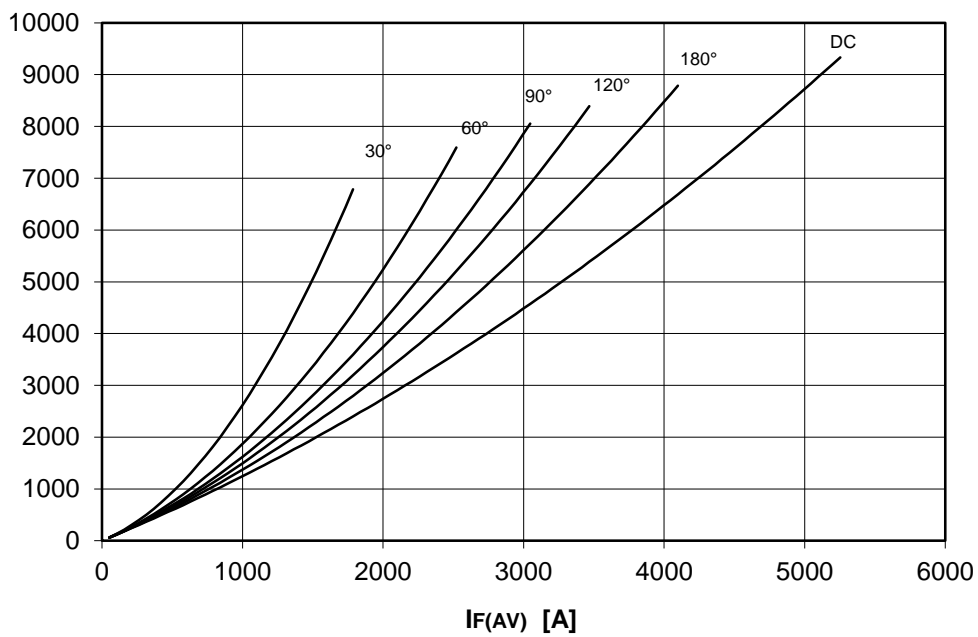

DISSIPATION CHARACTERISTICS

SINE WAVE

Th [°C]

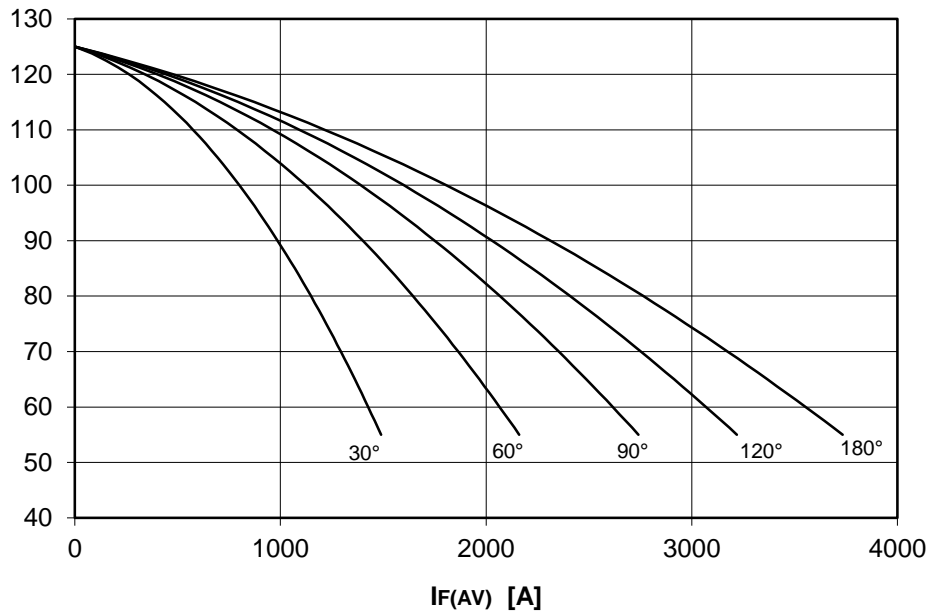

PF(AV) [W]

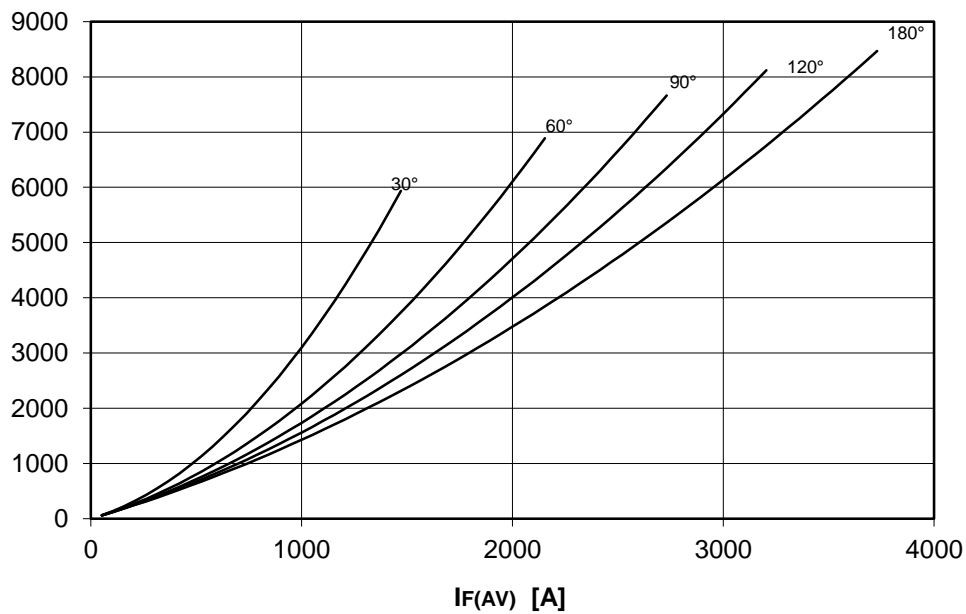

REVERSE RECOVERY CHARGE

$T_j = 125^\circ\text{C} - I_T = 3000 \text{ A}$

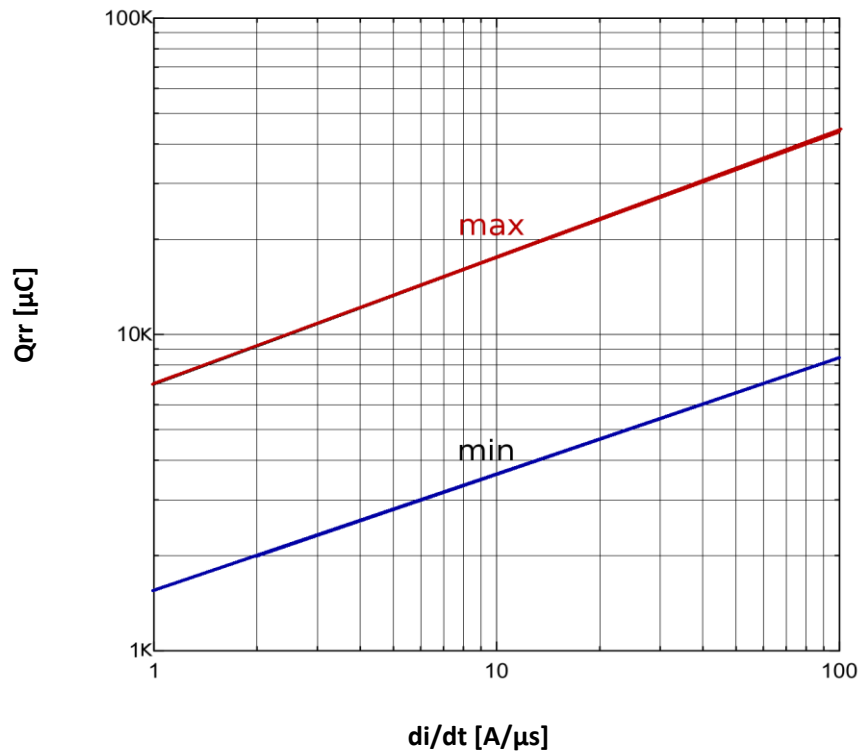

REVERSE RECOVERY CURRENT

$T_j = 125^\circ\text{C} - I_T = 3000 \text{ A}$

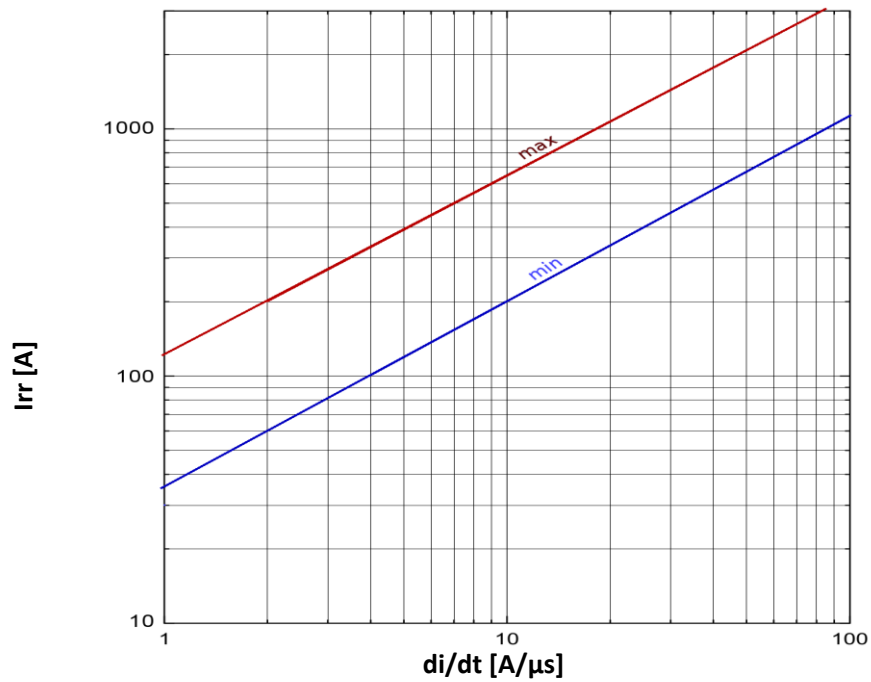

ON-STATE CHARACTERISTIC
T_j = 125 °C

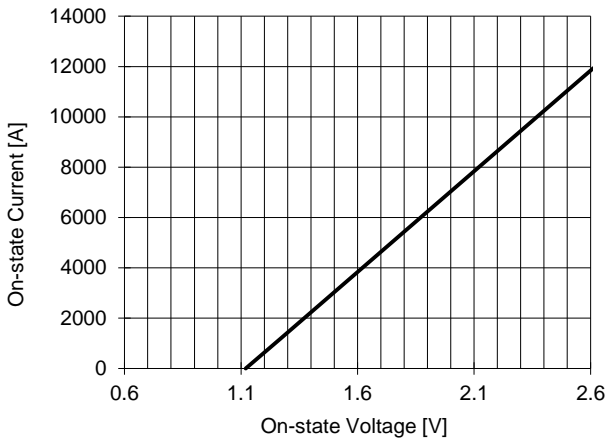

SURGE CHARACTERISTIC
T_j = 125 °C

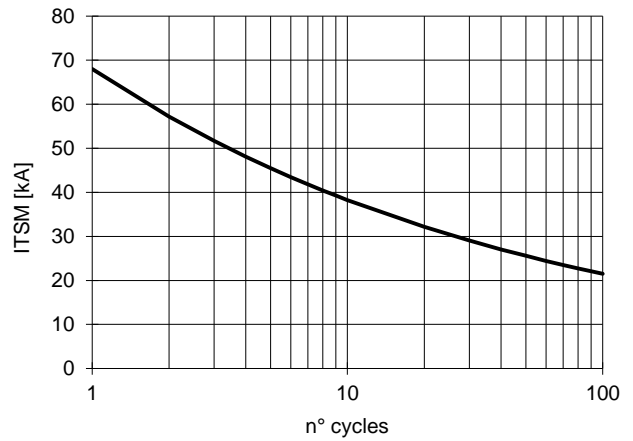

TRANSIENT THERMAL IMPEDANCE
DOUBLE SIDE COOLED

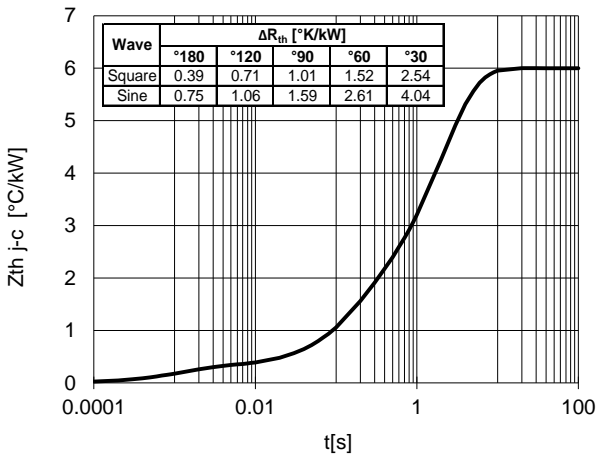

$$Z_{th\ j-c}(t) = \sum_{i=1}^n A_i * \left(1 - e^{-\frac{t}{\tau_i}}\right)$$

i	1	2	3	4
A _i [°C/kW]	2.738	1.779	1.186	0.297
τ _i [s]	2.4	1.70	0.16	0.001

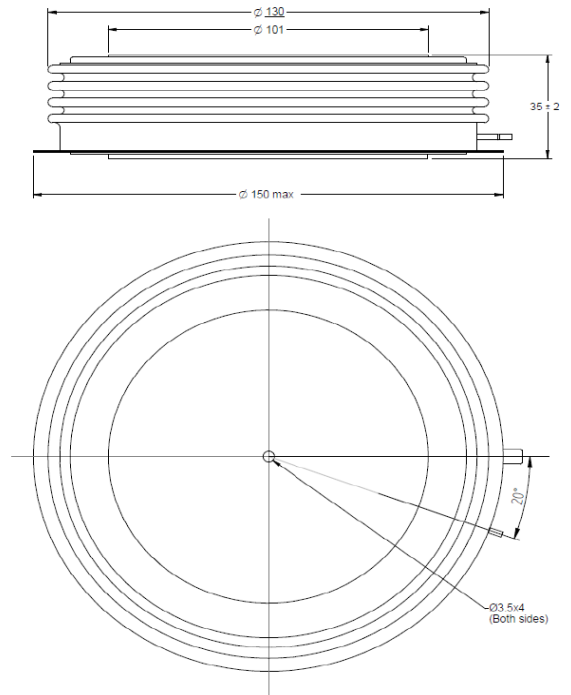

Dimensions in mm



Cathode terminal type DIN 46244 - A 4.8 - 0.8

Gate terminal type AMP 60598 - 1

All the characteristics given in this data sheet are guaranteed only with uniform clamping force, cleaned and lubricated heatsink, surfaces with flatness < .03 mm and roughness < 2 μm.

In the interest of product improvement POSEICO SpA reserves the right to change any data given in this data sheet at any time without previous notice.

If not stated otherwise the maximum value of ratings (symbols over shaded background) and characteristics is reported.

Distributed by

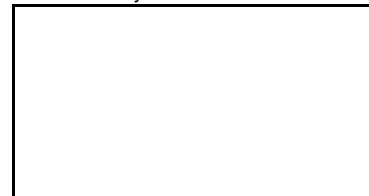

TRANSIENT THERMAL IMPEDANCE
DOUBLE SIDE COOLED

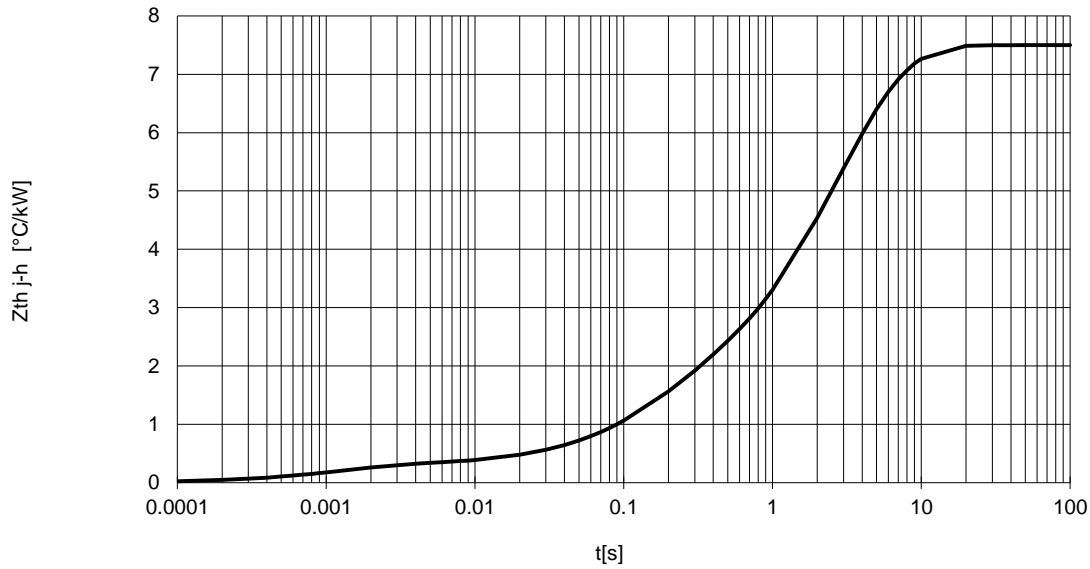

$$Z_{th\ j-h}(t) = \sum_{i=1}^n A_i * \left(1 - e^{-\frac{t}{\tau_i}}\right)$$

i	1	2	3	4
A _i [°C/kW]	4.320	1.701	1.183	0.296
τ _i [s]	3.400	1.800	0.160	0.001

Note:

This Z_{th j-h}(t) curve takes into account of a contact thermal resistance value R_{th c-h} = 1,5 °C/kW.

Mounting recommendations must be followed in order to match the specified contact thermal resistance value.