

## PHASE CONTROL THYRISTOR

# AT970

Repetitive voltage up to **3400 V**  
Mean on-state current **4128 A**  
Surge current **68 kA**

### FINAL SPECIFICATION

July 22 - Issue: 4

Symbol	Characteristic	Conditions	T <sub>j</sub> [°C]	Value	Unit
<b>BLOCKING</b>					
V <sub>RRM</sub>	Repetitive peak reverse voltage		125	3400	V
V <sub>RSM</sub>	Non-repetitive peak reverse voltage		125	3500	V
V <sub>DRM</sub>	Repetitive peak off-state voltage		125	3400	V
I <sub>RRM</sub>	Repetitive peak reverse current	V=V <sub>RRM</sub>	125	300	mA
I <sub>DRM</sub>	Repetitive peak off-state current	V=V <sub>DRM</sub>	125	300	mA
<b>CONDUCTING</b>					
I <sub>T(AV)</sub>	Mean on-state current	DC sin, 50 Hz, Th=55°C, double side cooled		4128	A
I <sub>T(AV)</sub>	Mean on-state current	DC sin, 50 Hz, Tc=85°C, double side cooled		3287	A
I <sub>TSM</sub>	Surge on-state current	sine wave, 10 ms	125	68.0	kA
I <sup>2</sup> t	I <sup>2</sup> t	without reverse voltage		23120 x1E3	A <sup>2</sup> s
V <sub>T</sub>	On-state voltage	On-state current = 7500 A	25	1.95	V
V <sub>T(TO)</sub>	Threshold voltage		125	1.12	V
r <sub>T</sub>	On-state slope resistance		125	0.112	mohm
<b>SWITCHING</b>					
di/dt	Critical rate of rise of on-state current, min.	From 67% V <sub>DRM</sub> , gate 10V 5ohm	125	200	A/μs
dv/dt	Critical rate of rise of off-state voltage, min.	Linear ramp up to 67% of V <sub>DRM</sub>	125	1000	V/μs
t <sub>d</sub>	Gate controlled delay time, typical	V <sub>D</sub> =100V, gate source 10V, 10 ohm, tr=5 μs	25		μs
t <sub>q</sub>	Circuit commutated turn-off time, typical	dv/dt = 20 V/μs linear up to 75% V <sub>DRM</sub>		700	μs
Q <sub>RR</sub>	Reverse recovery charge	di/dt=-20 A/μs, I= 2150 A	125		μC
I <sub>RR</sub>	Peak reverse recovery current	V <sub>R</sub> = 50 V			A
I <sub>H</sub>	Holding current, typical	V <sub>D</sub> =5V, gate open circuit	25	500	mA
I <sub>L</sub>	Latching current, typical	V <sub>D</sub> =12V, tp=50μs	25	1500	mA
<b>GATE</b>					
V <sub>GT</sub>	Gate trigger voltage	V <sub>D</sub> =12V	25	3.5	V
I <sub>GT</sub>	Gate trigger current	V <sub>D</sub> =12V	25	250	mA
V <sub>GD</sub>	Non-trigger gate voltage, min.	V <sub>D</sub> =67%V <sub>DRM</sub>	125	0.25	V
V <sub>FGM</sub>	Peak gate voltage (forward)			10	V
I <sub>FGM</sub>	Peak gate current			10	A
V <sub>RGM</sub>	Peak gate voltage (reverse)			10	V
P <sub>GM</sub>	Peak gate power dissipation	Pulse width 100 μs		150	W
P <sub>G</sub>	Average gate power dissipation			3	W
<b>MOUNTING</b>					
R <sub>th(j-c)</sub>	Thermal impedance, DC	Junction to case, double side cooled		6.0	°C/kW
R <sub>th(c-h)</sub>	Thermal impedance	Case to heatsink, double side cooled		1.5	°C/kW
T <sub>j</sub>	Operating junction temperature			-30 / 125	°C
F	Mounting force			80.0 / 100.0	kN
	Mass			3000	g
<b>ORDERING INFORMATION : AT970 S 34</b> standard specification <input type="checkbox"/> <input checked="" type="checkbox"/> V <sub>DRM</sub> &V <sub>RRM</sub> /100					

DISSIPATION CHARACTERISTICS

SQUARE WAVE

Th [°C]

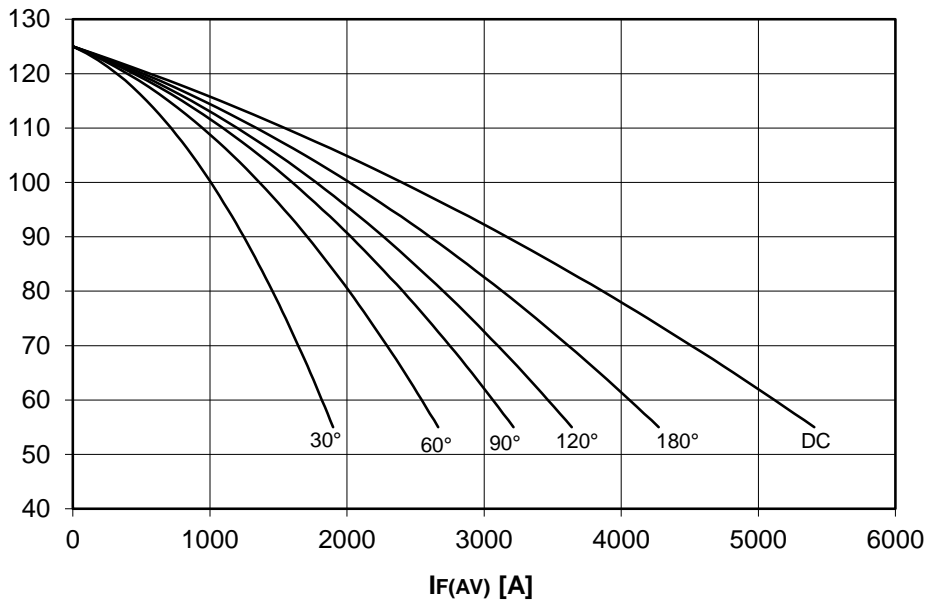

PF(AV) [W]

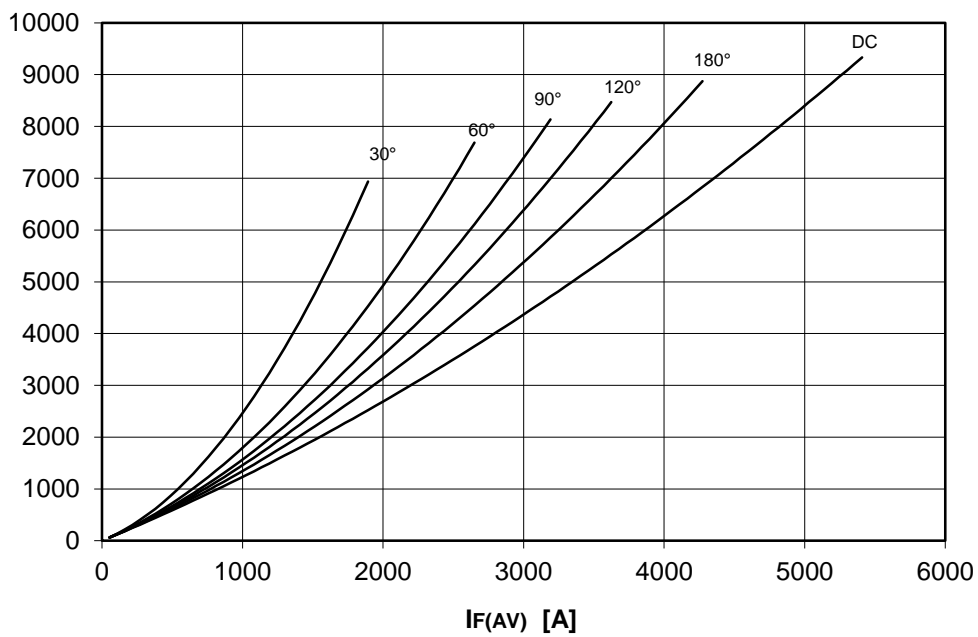

**DISSIPATION CHARACTERISTICS**

SINE WAVE

Th [°C]

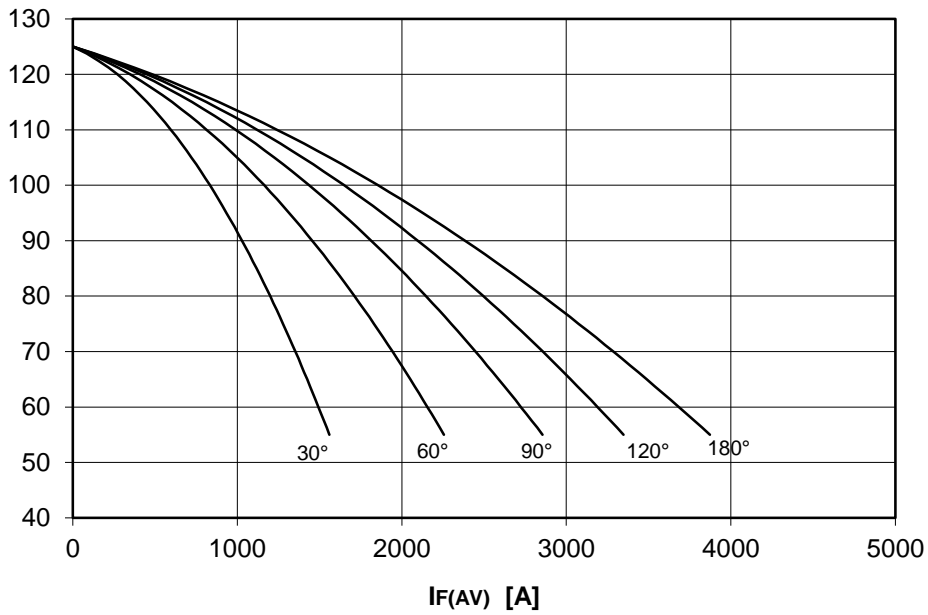

PF(AV) [W]

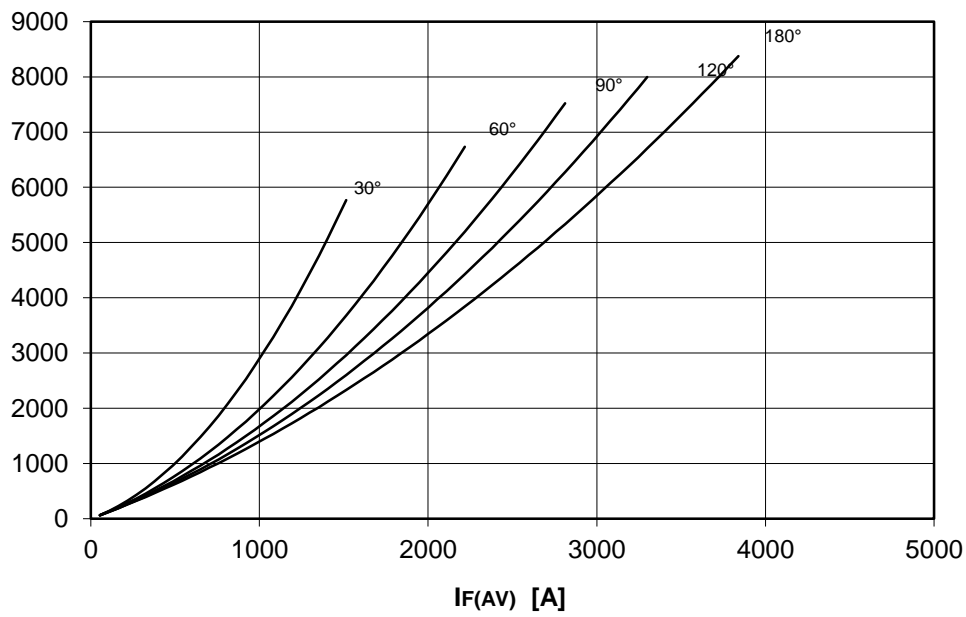

REVERSE RECOVERY CHARGE

$T_j = 125^\circ\text{C} - I_T = 3000\text{ A}$

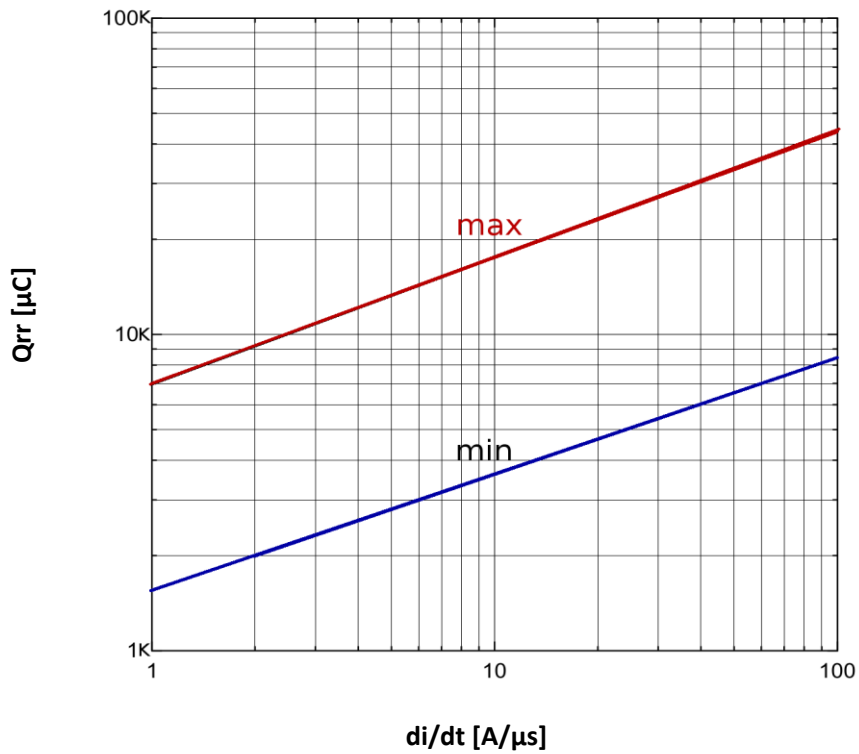

REVERSE RECOVERY CURRENT

$T_j = 125^\circ\text{C} - I_T = 3000\text{ A}$

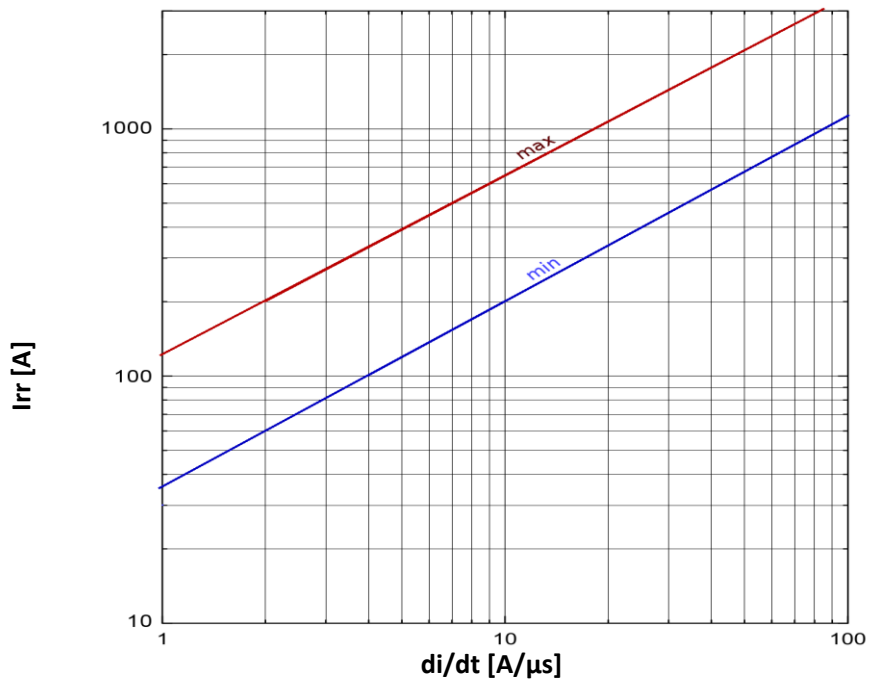

ON-STATE CHARACTERISTIC  
T<sub>j</sub> = 125 °C

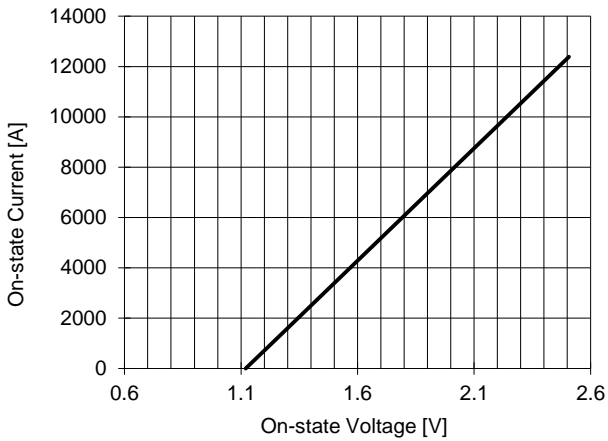

SURGE CHARACTERISTIC  
T<sub>j</sub> = 125 °C

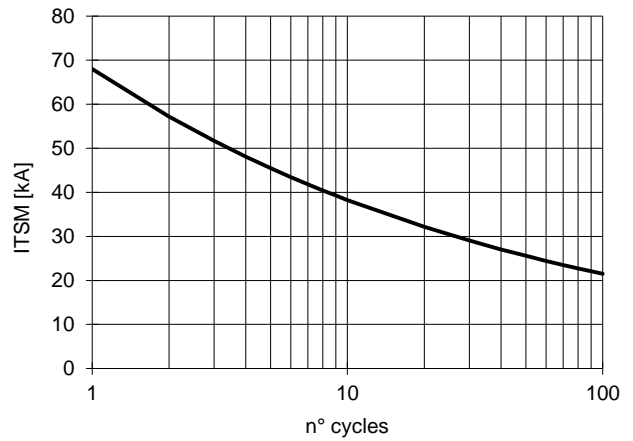

TRANSIENT THERMAL IMPEDANCE  
DOUBLE SIDE COOLED

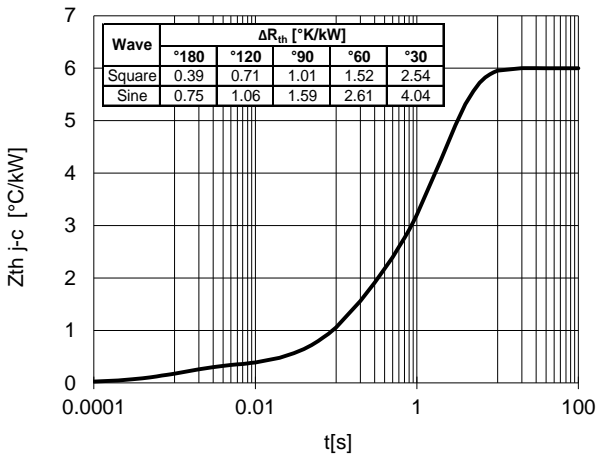

$$Z_{th\ j-c}(t) = \sum_{i=1}^n A_i * \left(1 - e^{-\frac{t}{\tau_i}}\right)$$

i	1	2	3	4
A <sub>i</sub> [°C/kW]	2.738	1.779	1.186	0.297
τ <sub>i</sub> [s]	2.4	1.70	0.16	0.001

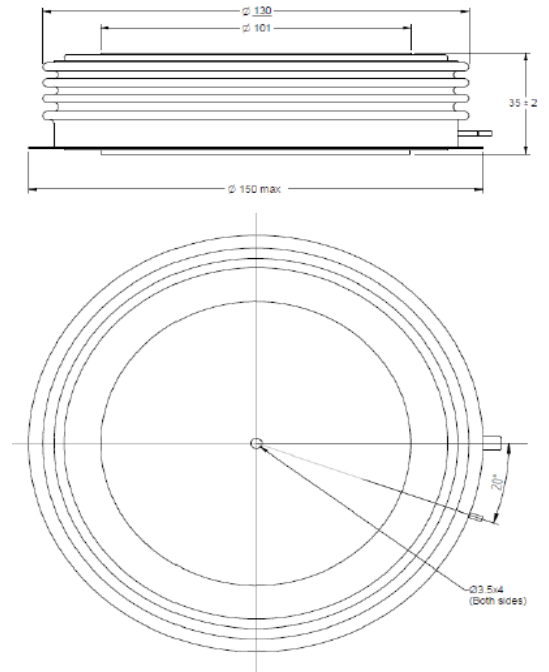

Dimensions  
in mm



Cathode terminal type DIN 46244 - A 4.8 - 0.8

Gate terminal type AMP 60598 - 1

All the characteristics given in this data sheet are guaranteed only with uniform clamping force, cleaned and lubricated heatsink, surfaces with flatness < .03 mm and roughness < 2 μm.

In the interest of product improvement POSEICO SpA reserves the right to change any data given in this data sheet at any time without previous notice.

If not stated otherwise the maximum value of ratings (symbols over shaded background) and characteristics is reported.

Distributed by

