

PHASE CONTROL THYRISTOR

AT908

Repetitive voltage up to **800 V**
Mean on-state current **6976 A**
Surge current **95 kA**

FINAL SPECIFICATION

Apr. 24 - Issue: 11

Symbol	Characteristic	Conditions	T _j [°C]	Value	Unit
BLOCKING					
V _{RRM}	Repetitive peak reverse voltage		140	800	V
V _{RSM}	Non-repetitive peak reverse voltage		140	900	V
V _{DRM}	Repetitive peak off-state voltage		140	800	V
I _{RRM}	Repetitive peak reverse current	V=VRRM	140	300	mA
I _{DRM}	Repetitive peak off-state current	V=VDRM	140	300	mA
CONDUCTING					
I _{T(AV)}	Mean on-state current	180° sin, 50 Hz, Th=55°C, double side cooled		6976	A
I _{T(AV)}	Mean on-state current	180° sin, 50 Hz, Tc=85°C, double side cooled		6032	A
I _{TSM}	Surge on-state current	sine wave, 10 ms	140	95.0	kA
I ² t	I ² t	VR=50%VRRM		45125 x1E3	A ² s
V _T	On-state voltage	On-state current = 9000 A	25	1.26	V
V _{T(TO)}	Threshold voltage		140	0.85	V
r _T	On-state slope resistance		140	0.045	mohm
SWITCHING					
di/dt	Critical rate of rise of on-state current, min.	From 75% VDRM, gate 10V 5ohm	140	200	A/μs
dv/dt	Critical rate of rise of off-state voltage, min.	Linear ramp up to 70% of VDRM	140	1000	V/μs
td	Gate controlled delay time, typical	VD=100V, gate source 10V, 10 ohm, tr=5 μs	25		μs
tq	Circuit commutated turn-off time, typical	dv/dt = 200 V/μs linear up to 70% VDRM		850	μs
Q _{RR}	Reverse recovery charge	di/dt=-10 A/μs, I= 1000 A	140	8500	μC
I _{RR}	Peak reverse recovery current	VR= 50 V			A
I _H	Holding current, typical	VD=5V, gate open circuit	25	500	mA
I _L	Latching current, typical	VD=12V, tp=30μs	25	3000	mA
GATE					
V _{GT}	Gate trigger voltage	VD=12V	25	3.5	V
I _{GT}	Gate trigger current	VD=12V	25	400	mA
V _{GD}	Non-trigger gate voltage, min.	VD=VDRM	140	0.4	V
V _{FGM}	Peak gate voltage (forward)			10	V
I _{FGM}	Peak gate current			10	A
V _{RGM}	Peak gate voltage (reverse)			10	V
P _{GM}	Peak gate power dissipation	Pulse width 100 μs		150	W
P _G	Average gate power dissipation			3	W
MOUNTING					
R _{th(j-c)}	Thermal impedance, DC	Junction to case, double side cooled		6.0	°C/kW
R _{th(c-h)}	Thermal impedance	Case to heatsink, double side cooled		1.5	°C/kW
T _j	Operating junction temperature			-30 / 140	°C
F	Mounting force			80.0 / 100.0	kN
	Mass			3000	g
ORDERING INFORMATION : AT908 S 08 standard specification <input type="checkbox"/> <input type="checkbox"/> VDRM&VRRM/100					

DISSIPATION CHARACTERISTICS

SQUARE WAVE

Th [°C]

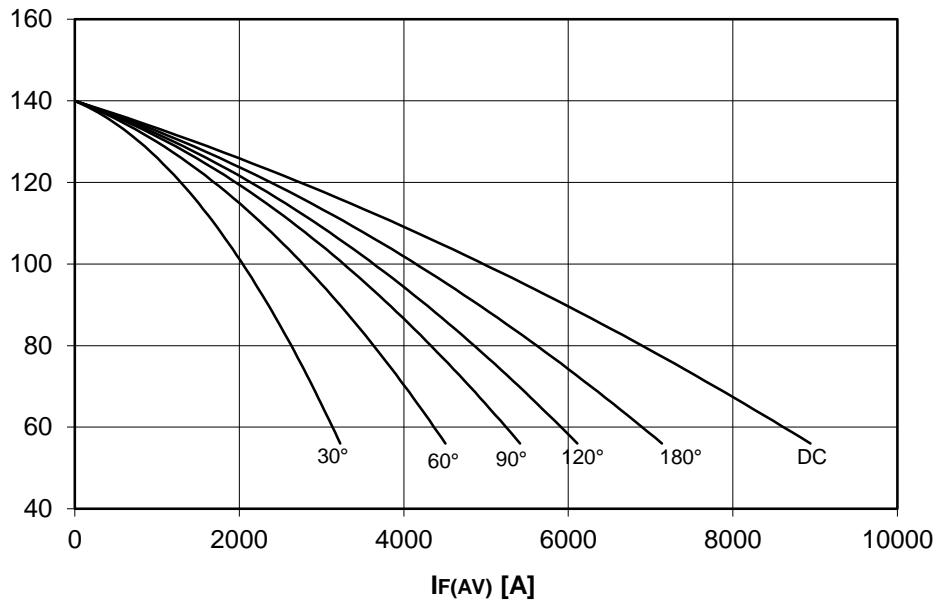

PF(AV) [W]

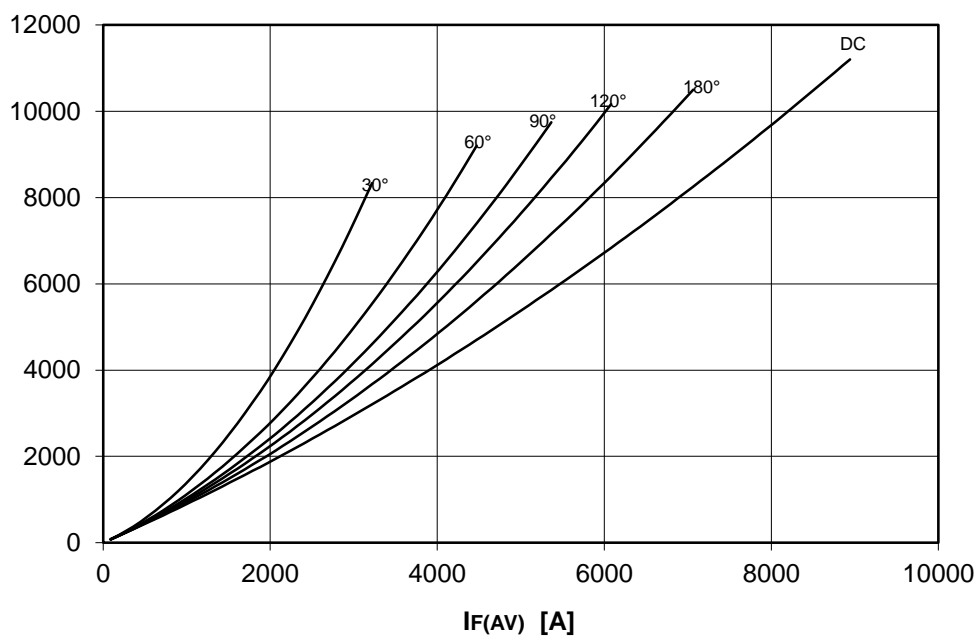

DISSIPATION CHARACTERISTICS

SINE WAVE

Th [°C]

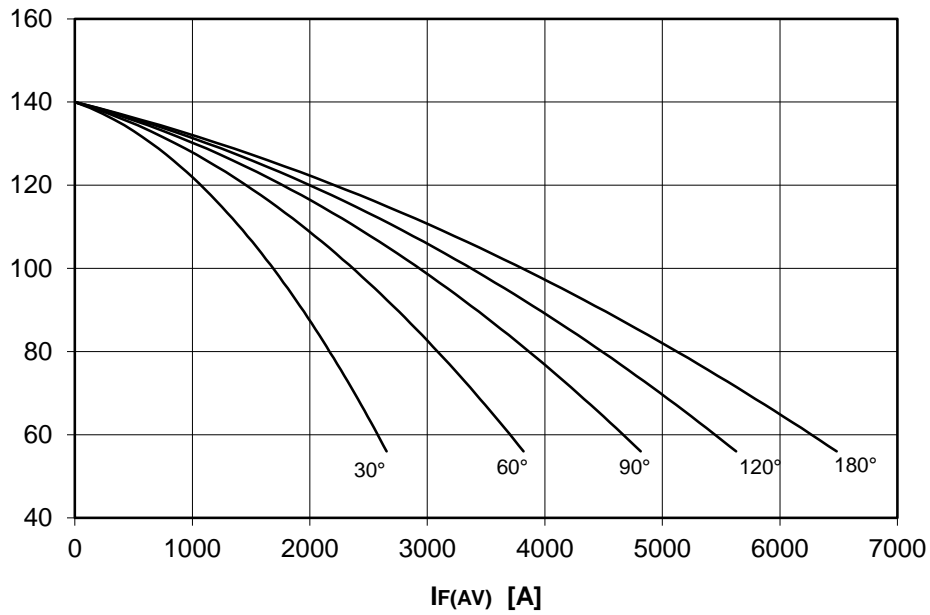

PF(AV) [W]

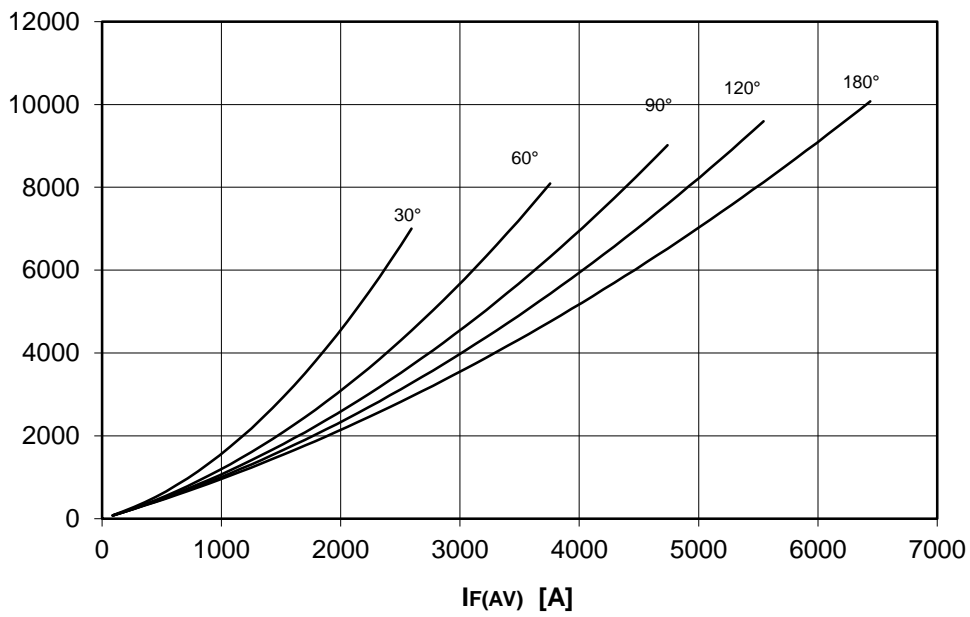

ON-STATE CHARACTERISTIC
T_j = 140 °C

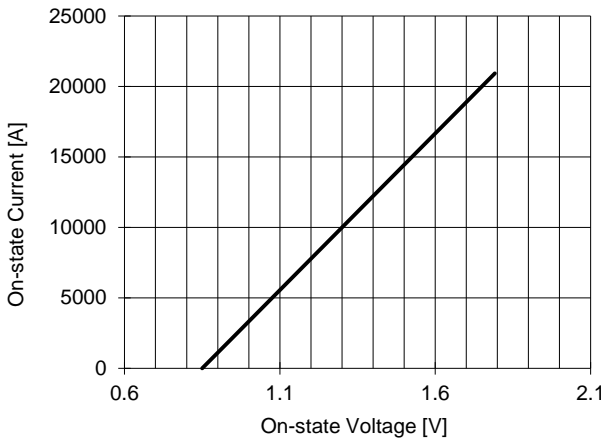

SURGE CHARACTERISTIC
T_j = 140 °C

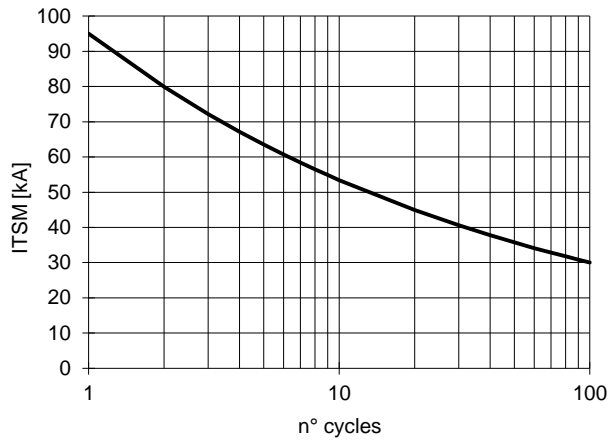

TRANSIENT THERMAL IMPEDANCE
DOUBLE SIDE COOLED

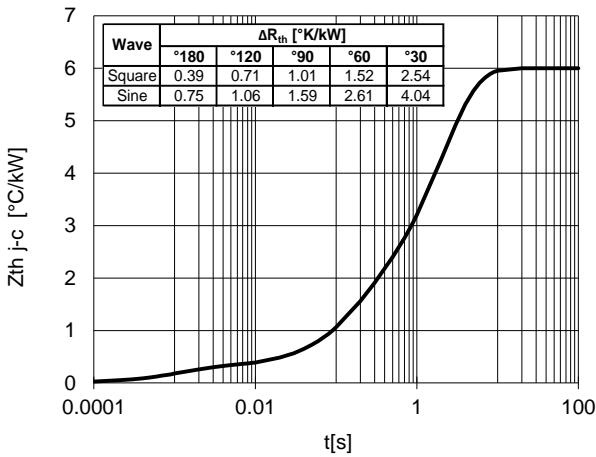

$$Z_{th\ j-c}(t) = \sum_{i=1}^n A_i * \left(1 - e^{-\frac{t}{\tau_i}}\right)$$

i	1	2	3	4
A _i [°C/kW]	2.738	1.779	1.186	0.297
τ _i [s]	2.4	1.70	0.16	0.001

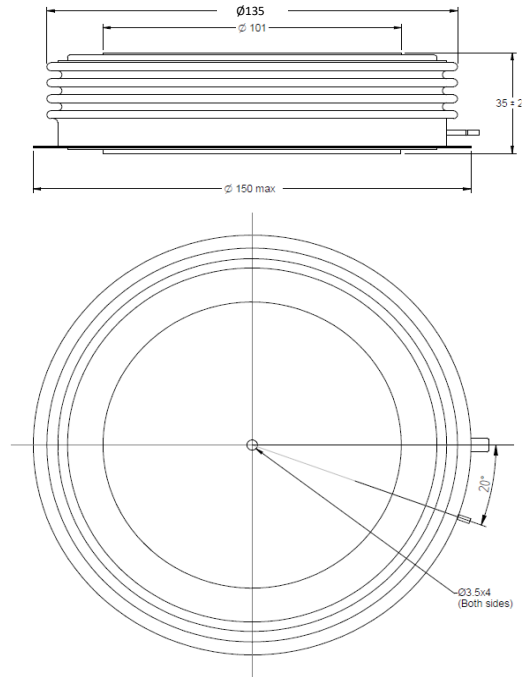

Dimensions
in mm



All the characteristics given in this data sheet are guaranteed only with uniform clamping force, cleaned and lubricated heatsink, surfaces with flatness < .03 mm and roughness < 2 μm.

In the interest of product improvement POSEICO SpA reserves the right to change any data given in this data sheet at any time without previous notice.

If not stated otherwise the maximum value of ratings (symbols over shaded background) and characteristics is reported.

Distributed by

