

PHASE CONTROL THYRISTOR

AT746

Repetitive voltage up to

2600 V

Mean forward current

1794 A

Surge current

25 kA

FINAL SPECIFICATION

Feb. 17 - Issue: 1

Symbol	Characteristic	Conditions	T _j [°C]	Value	Unit
BLOCKING					
V _{RRM}	Repetitive peak reverse voltage		125	2600	V
V _{RSM}	Non-repetitive peak reverse voltage		125	2700	V
V _{DRM}	Repetitive peak off-state voltage		125	2600	V
I _{RRM}	Repetitive peak reverse current	V=VRRM	125	100	mA
I _{DRM}	Repetitive peak off-state current	V=VDRM	125	100	mA
CONDUCTING					
I _{T(AV)}	Mean forward current	180° sin, 50 Hz, Th=55°C, double side cooled		1794	A
I _{T(AV)}	Mean forward current	180° sin, 50 Hz, Tc=85°C, double side cooled		1404	A
I _{TSM}	Surge forward current	Sine wave, 10 ms	125	25	kA
I ² t	I ² t	without reverse voltage		3125 x 10 ³	A ² s
V _T	On-state voltage	On-state current = 5600 A	25	2,80	V
V _{T(TO)}	Threshold voltage		125	1,10	V
r _T	On-state slope resistance		125	0,270	mohm
SWITCHING					
di/dt	Critical rate of rise of on-state current, min.	From 75% VDRM up to 1800 A; gate 10V, 5Ω	125	200	A/μs
dv/dt	Critical rate of rise of off-state voltage, min.	Linear ramp up to 70% of VDRM	125	500	V/μs
t _d	Gate controlled delay time, typical	VD=100V; gate source 25V, 10Ω, tr=.5 μs	25	1	μs
t _q	Circuit commutated turn-off time, typical	dv/dt = 20 V/μs linear up to 75% VDRM		350	μs
Q _{rr}	Reverse recovery charge	di/dt = -20 A/μs, I= 1500 A	125		μC
I _{rr}	Peak reverse recovery current	VR= 50 V			A
I _H	Holding current, typical	VD=5V, gate open circuit	25	500	mA
I _L	Latching current, typical	VD=5V, tp=30μs	25	2	mA
GATE					
V _{GT}	Gate trigger voltage	VD=5V	25	3,50	V
I _{GT}	Gate trigger current	VD=5V	25	300	mA
V _{GD}	Non-trigger gate voltage, min.	VD=VDRM	125	0,25	V
V _{FGM}	Peak gate voltage (forward)			30	V
I _{FGM}	Peak gate current			10	A
V _{RGM}	Peak gate voltage (reverse)			5	V
P _{GM}	Peak gate power dissipation	Pulse width 100 μs		150	W
P _G	Average gate power dissipation			2	W
MOUNTING					
R _{th(j-h)}	Thermal impedance, DC	Junction to heatsink, double side cooled		17,0	°C/kW
R _{th(c-h)}	Thermal impedance	Case to heatsink, double side cooled		3,0	°C/kW
T _j	Operating junction temperature			-30 / 125	°C
F	Mounting force			40,0 / 50,0	kN
	Mass			1000	g

ORDERING INFORMATION : AT746 S 26

standard specification VRRM/100

DISSIPATION CHARACTERISTICS

SQUARE WAVE

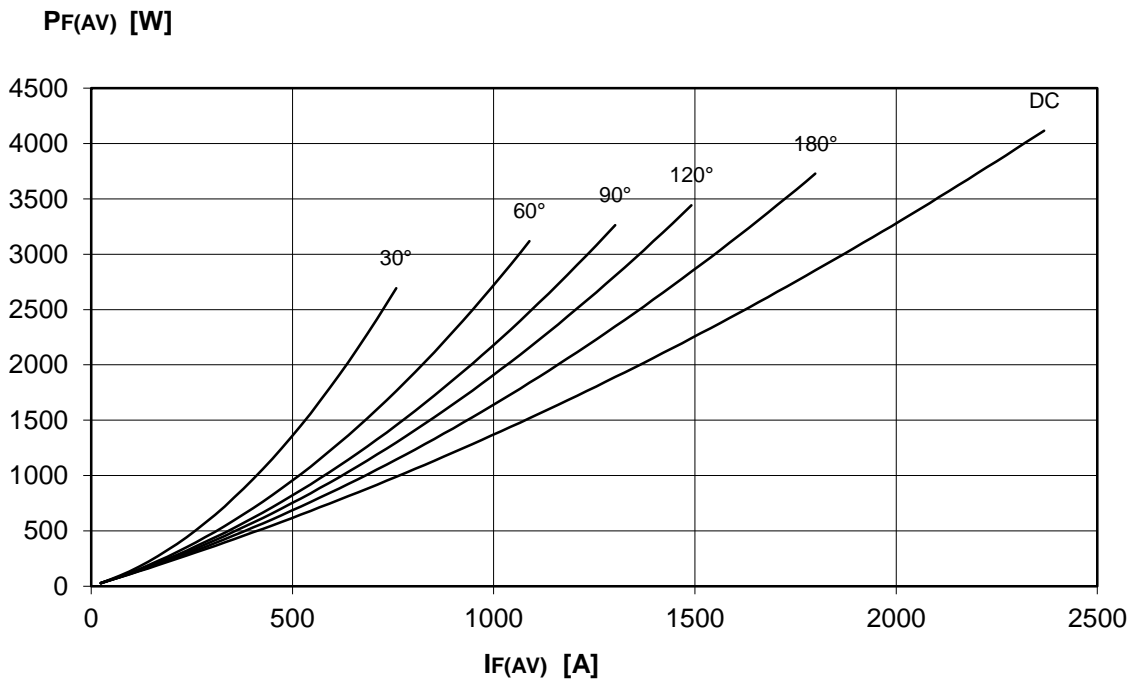
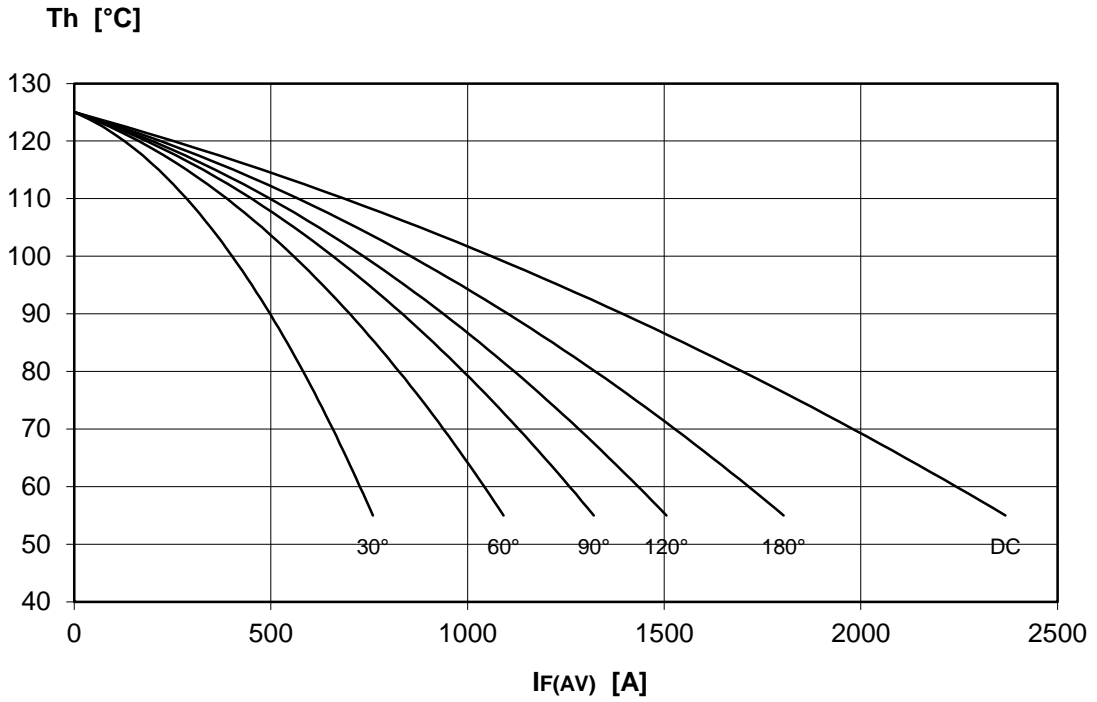

DISSIPATION CHARACTERISTICS

SINE WAVE

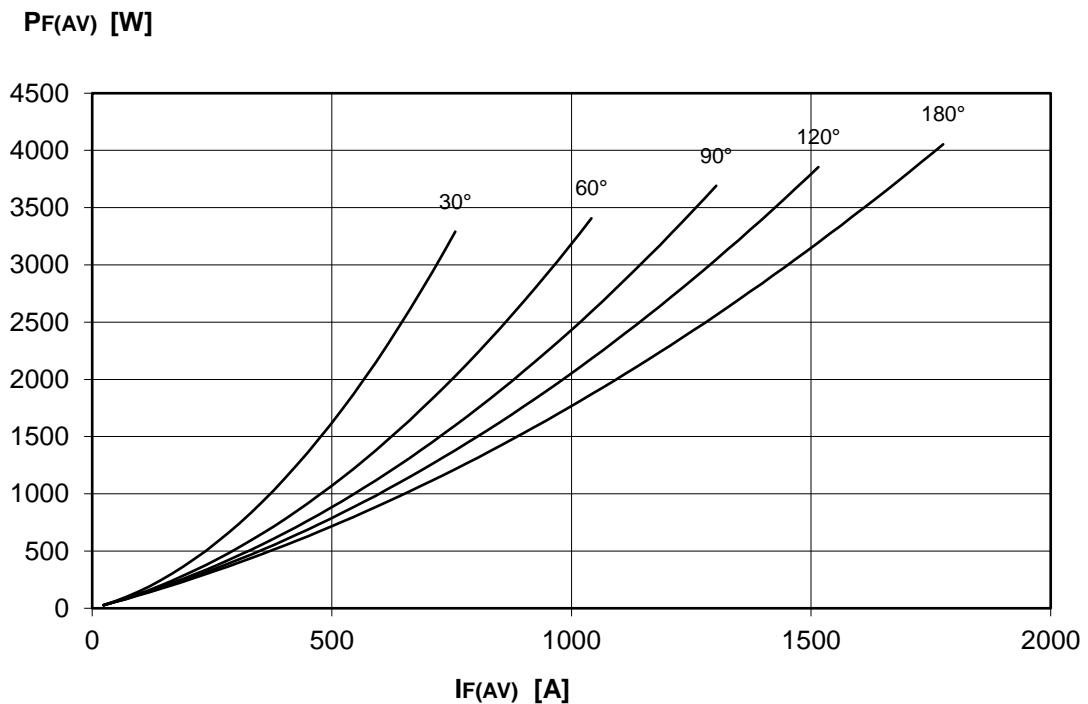
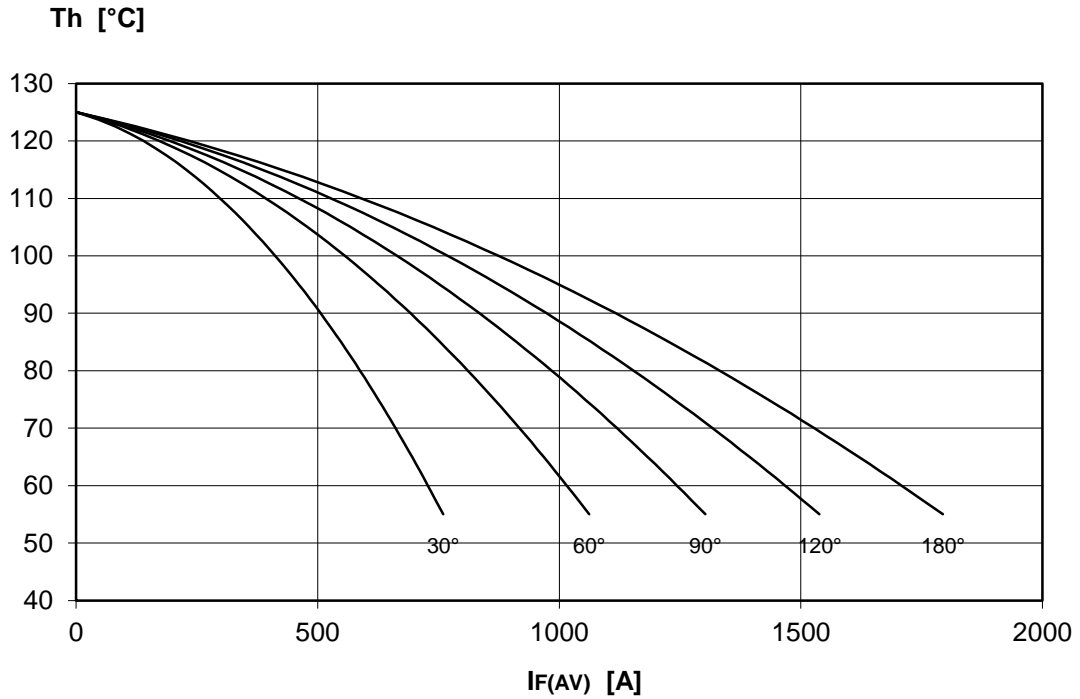

AT746 PHASE CONTROL THYRISTOR



FINAL SPECIFICATION Feb. 17 - Issue: 1

ON-STATE CHARACTERISTIC
T_j = 125 °C

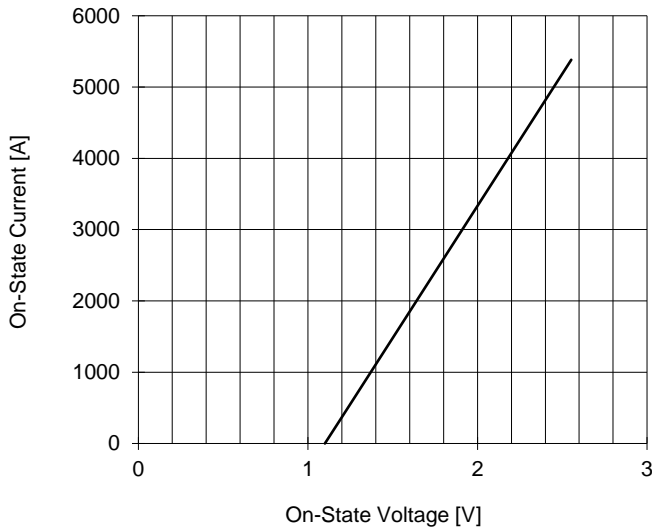

SURGE CHARACTERISTIC
T_j = 125 °C

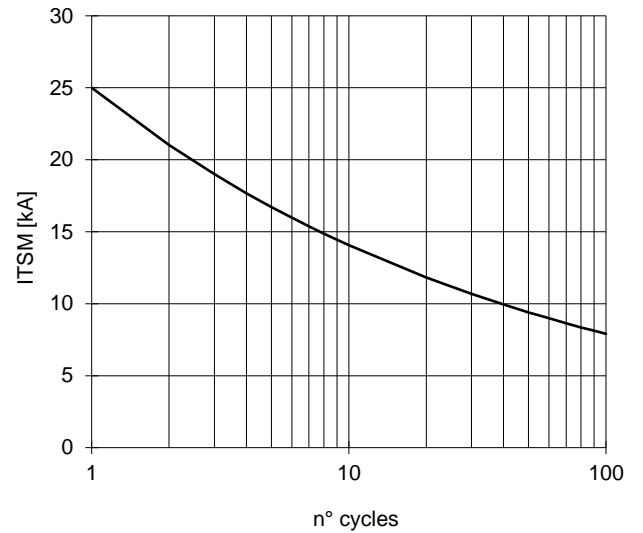

TRANSIENT THERMAL IMPEDANCE
DOUBLE SIDE COOLED

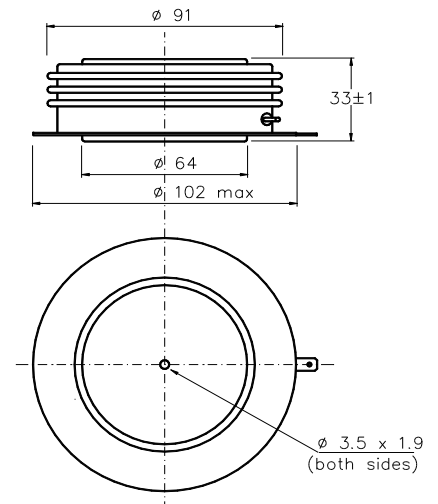
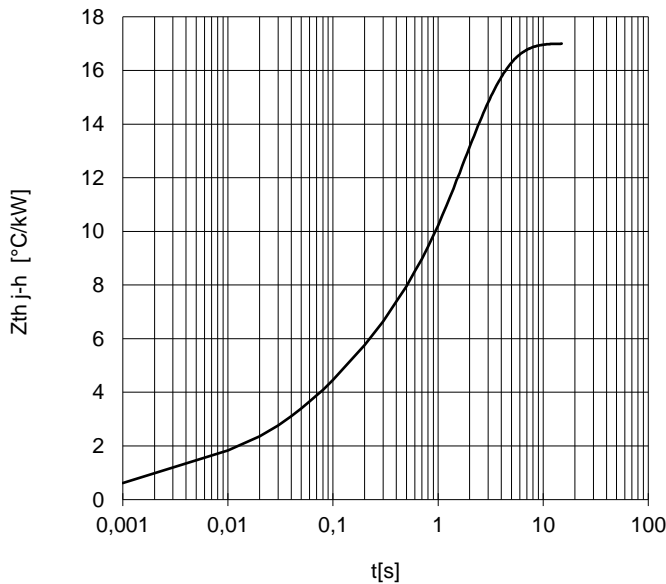

Dimensions
in mm



Cathode terminal type DIN 46244 - A 4.8 - 0.8

Gate terminal type AMP 60598 - 1

Distributed by

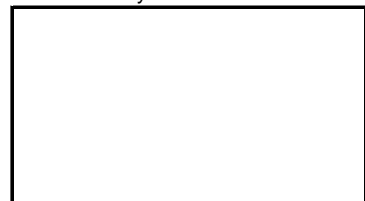

All the characteristics given in this data sheet are guaranteed only with uniform clamping force, cleaned and lubricated heatsink, surfaces with flatness < .03 mm and roughness < 2 µm. In the interest of product improvement POSEICO SpA reserves the right to change any data given in this data sheet at any time without previous notice. If not stated otherwise the maximum value of ratings (symbols over shaded background) and characteristics is reported.