

RECTIFIER DIODE

AR772

Repetitive voltage up to	5000 V
Mean forward current	4174 A
Surge current	45 kA

FINAL SPECIFICATION

Mar. 17 - Issue: 2

Symbol	Characteristic	Conditions	T _j [°C]	Value	Unit
BLOCKING					
V _{RRM}	Repetitive peak reverse voltage		175	5000	V
V _{RSM}	Non-repetitive peak reverse voltage		175	5100	V
I _{RRM}	Repetitive peak reverse current	V=VRRM	175	200	mA
CONDUCTING					
I _{F(AV)}	Mean forward current	180° sin, 50 Hz, Th=55°C, double side cooled		4174	A
I _{F(AV)}	Mean forward current	180° sin, 50 Hz, Tc=85°C, double side cooled		3966	A
I _{FSM}	Surge forward current	Sine wave, 10 ms without reverse voltage	175	45	kA
I ² t	I ² t			10125 x 10 ³	A ² s
V _{FM}	Forward voltage	Forward current = 3000 A	25	1,45	V
V _{F(TO)}	Threshold voltage		175	0,76	V
r _F	Forward slope resistance		175	0,180	mohm
SWITCHING					
t _{rr}	Reverse recovery time	I = 1600 A, di/dt = 2 A/μs	175		μs
Q _{rr}	Reverse recovery charge			650	μC
I _{rr}	Peak reverse recovery current				A
MOUNTING					
R _{th(j-h)}	Thermal impedance, DC	Junction to heatsink, double side cooled		11,0	°C/kW
R _{th(c-h)}	Thermal impedance	Case to heatsink, double side cooled		2,0	°C/kW
T _j	Operating junction temperature			-30 / 175	°C
F	Mounting force			46.0 / 54.0	kN
	Mass			1700	g
ORDERING INFORMATION : AR772 S 50 standard specification  VRRM/100					

DISSIPATION CHARACTERISTICS

SQUARE WAVE

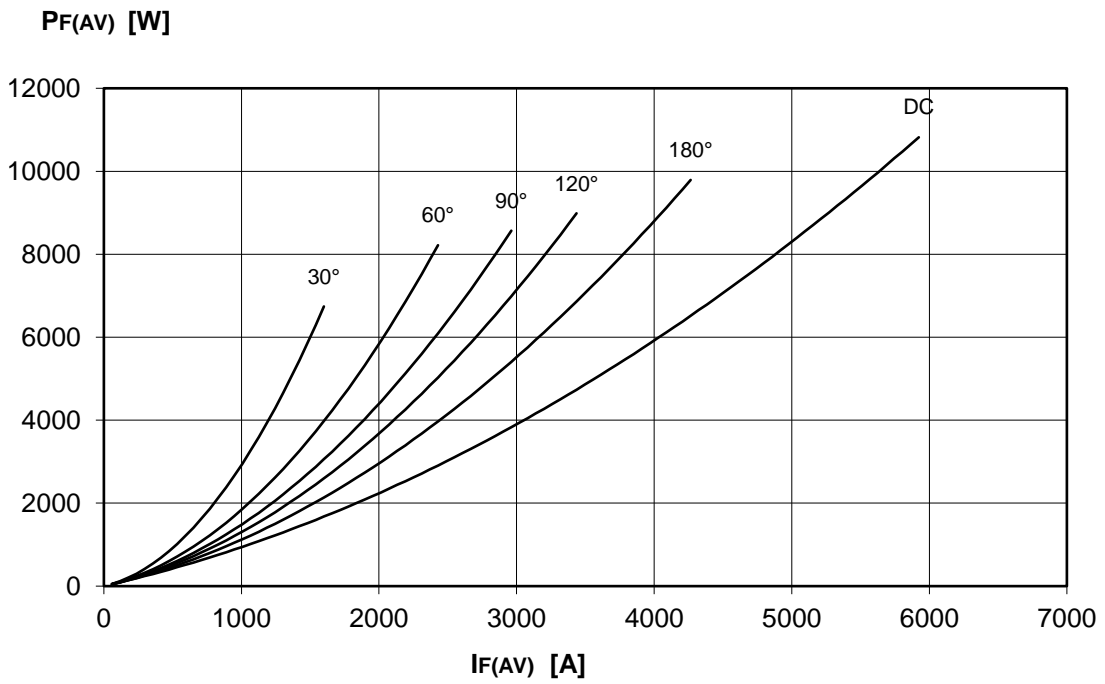
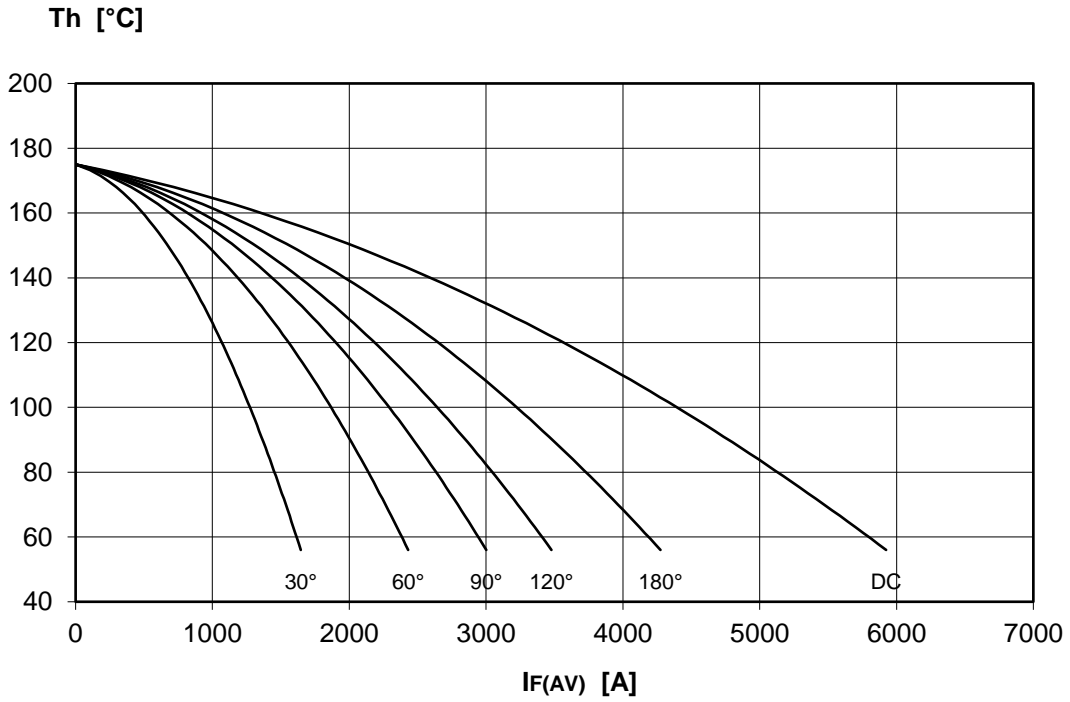

DISSIPATION CHARACTERISTICS

SINE WAVE

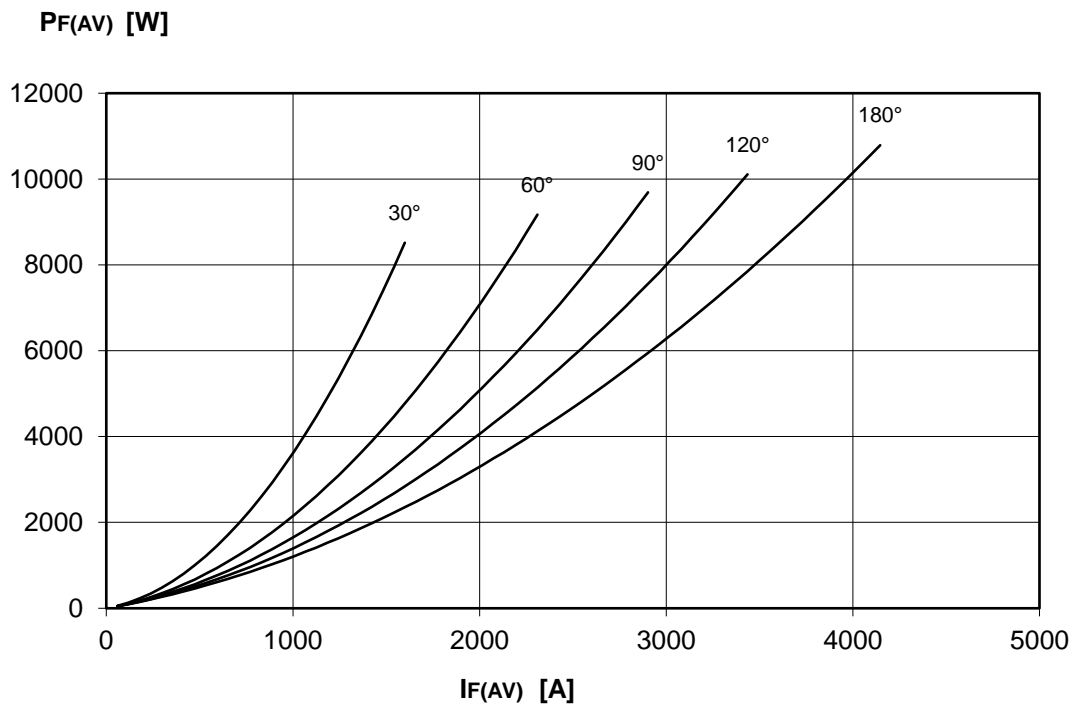
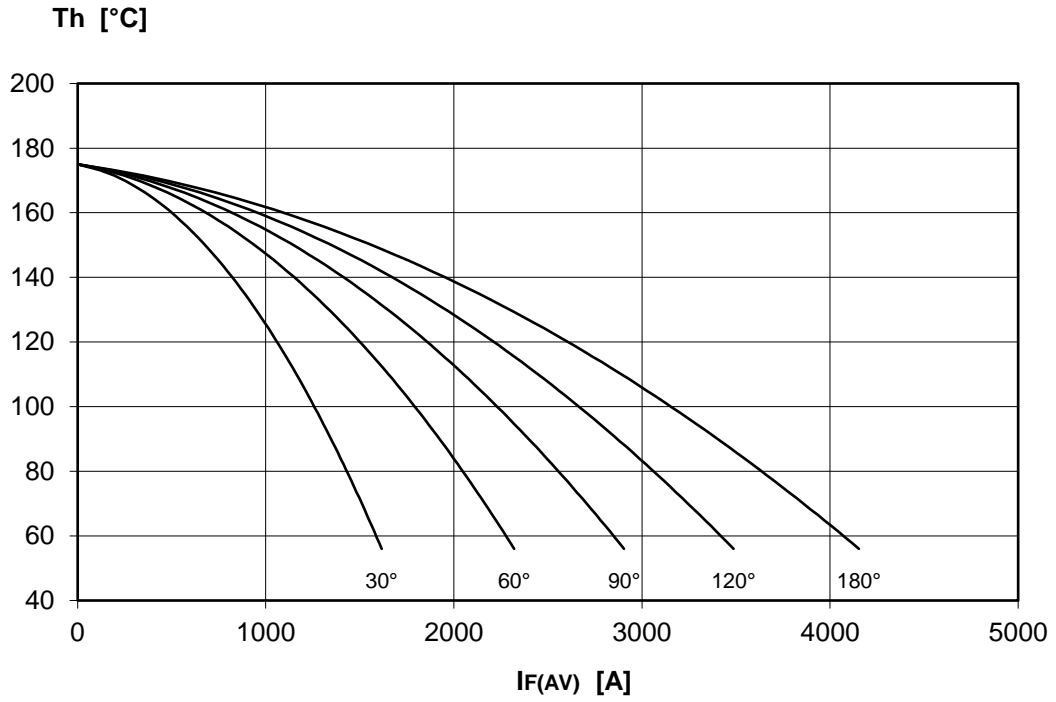

AR772 RECTIFIER DIODE



FINAL SPECIFICATION Mar. 17 - Issue: 2

FORWARD CHARACTERISTIC
T_j = 175 °C

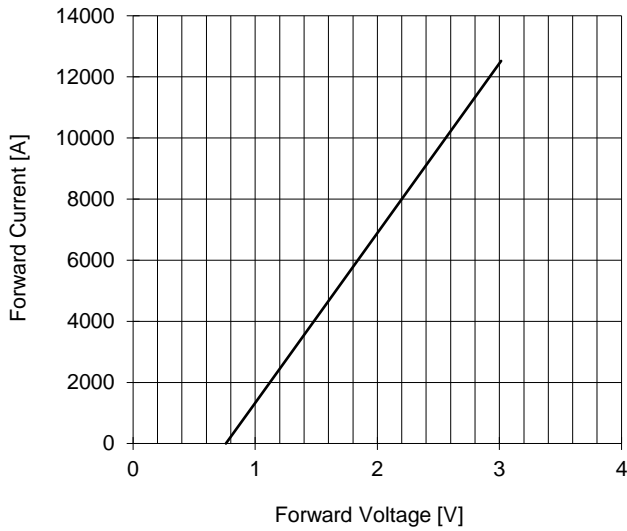

SURGE CHARACTERISTIC
T_j = 175 °C

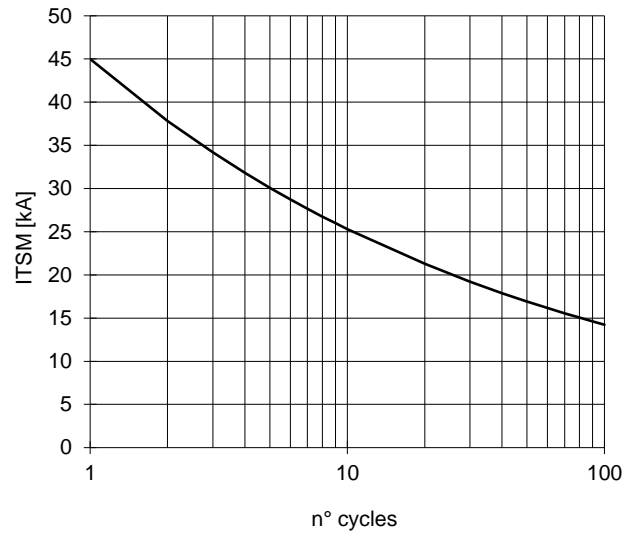

TRANSIENT THERMAL IMPEDANCE
DOUBLE SIDE COOLED

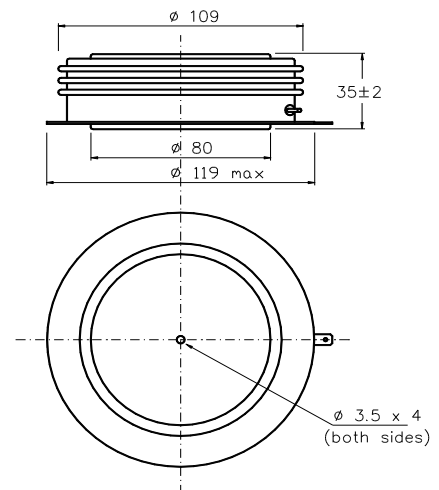
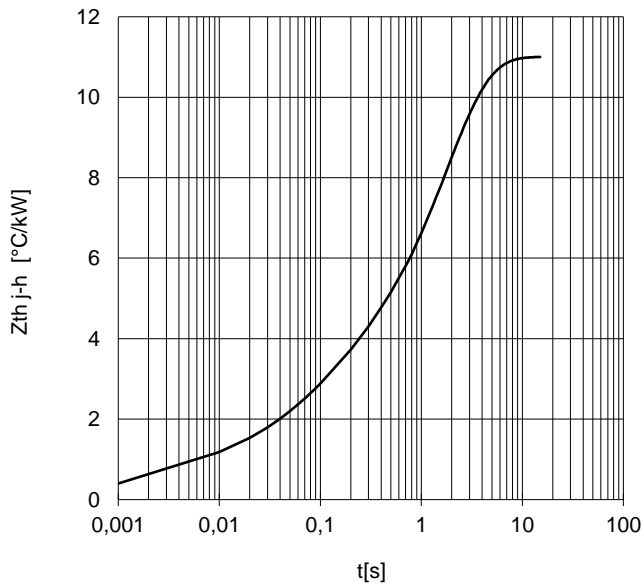

Dimensions
in mm



Distributed by

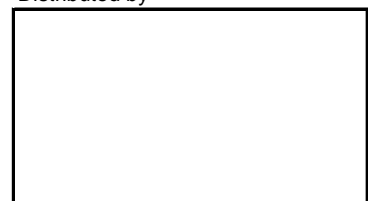

All the characteristics given in this data sheet are guaranteed only with uniform clamping force, cleaned and lubricated heatsink, surfaces with flatness < .03 mm and roughness < 2 μm.

In the interest of product improvement POSEICO SpA reserves the right to change any data given in this data sheet at any time without previous notice.

If not stated otherwise the maximum value of ratings (symbols over shaded background) and characteristics is reported.