

**RECTIFIER DIODE**

# AR649

Repetitive voltage up to	<b>2500 V</b>
Mean forward current	<b>4644 A</b>
Surge current	<b>45 kA</b>

**FINAL SPECIFICATION**

Mar. 17 - Issue: 4

Symbol	Characteristic	Conditions	T <sub>j</sub> [°C]	Value	Unit
<b>BLOCKING</b>					
V <sub>RRM</sub>	Repetitive peak reverse voltage		175	2500	V
V <sub>RSM</sub>	Non-repetitive peak reverse voltage		175	2600	V
I <sub>RRM</sub>	Repetitive peak reverse current	V=VRRM	175	100	mA
<b>CONDUCTING</b>					
I <sub>F(AV)</sub>	Mean forward current	180° sin, 50 Hz, Th=55°C, double side cooled		4644	A
I <sub>F(AV)</sub>	Mean forward current	180° sin, 50 Hz, Tc=85°C, double side cooled		4512	A
I <sub>FSM</sub>	Surge forward current	Sine wave, 10 ms without reverse voltage	175	45	kA
I <sup>2</sup> t	I <sup>2</sup> t			10125 x 10 <sup>3</sup>	A <sup>2</sup> s
V <sub>FM</sub>	Forward voltage	Forward current = 2000 A	25	0,90	V
V <sub>F(TO)</sub>	Threshold voltage		175	0,70	V
r <sub>F</sub>	Forward slope resistance		175	0,10	mohm
<b>SWITCHING</b>					
t <sub>rr</sub>	Reverse recovery time		175		μs
Q <sub>rr</sub>	Reverse recovery charge				μC
I <sub>rr</sub>	Peak reverse recovery current				A
<b>MOUNTING</b>					
R <sub>th(j-h)</sub>	Thermal impedance, DC	Junction to heatsink, double side cooled		14,0	°C/kW
R <sub>th(c-h)</sub>	Thermal impedance	Case to heatsink, double side cooled		3,0	°C/kW
T <sub>j</sub>	Operating junction temperature			-30 / 175	°C
F	Mounting force			35.0 / 40.0	kN
	Mass			850	g
<b>ORDERING INFORMATION : AR649 S 25</b> standard specification  VRRM/100					

**DISSIPATION CHARACTERISTICS**

SQUARE WAVE

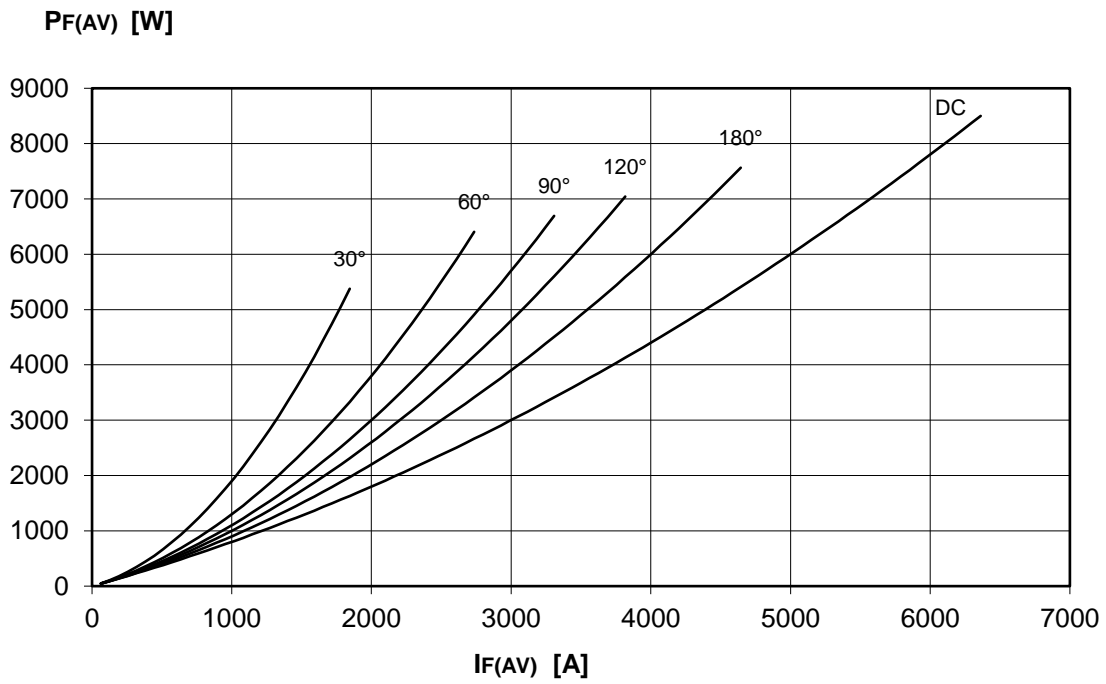
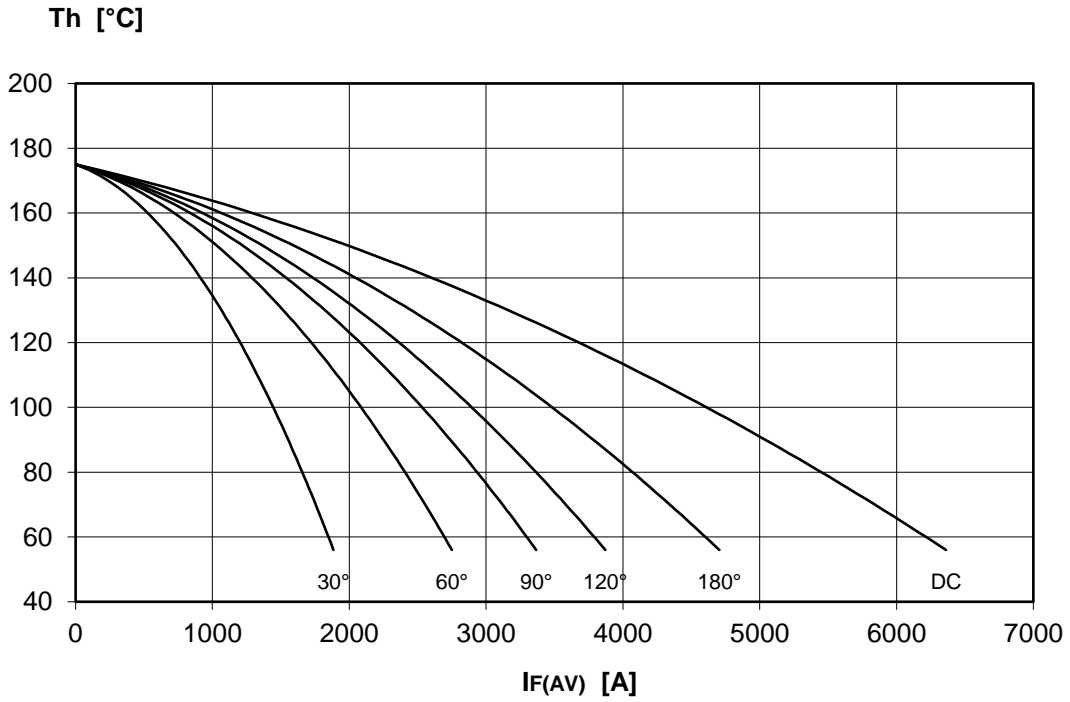

**DISSIPATION CHARACTERISTICS**

SINE WAVE

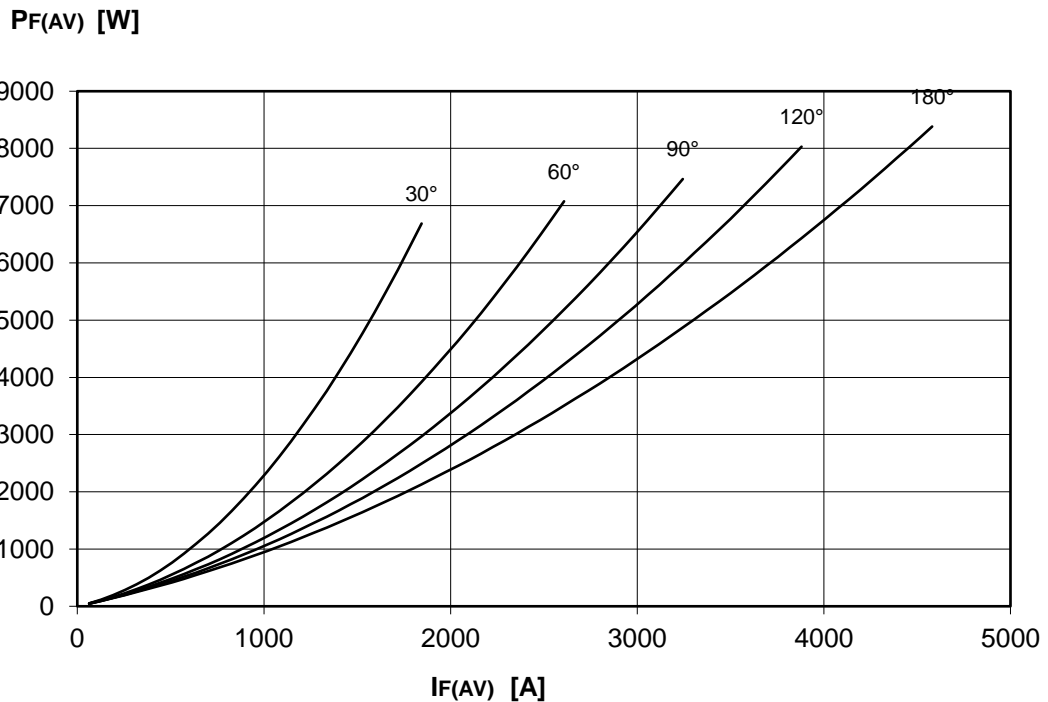
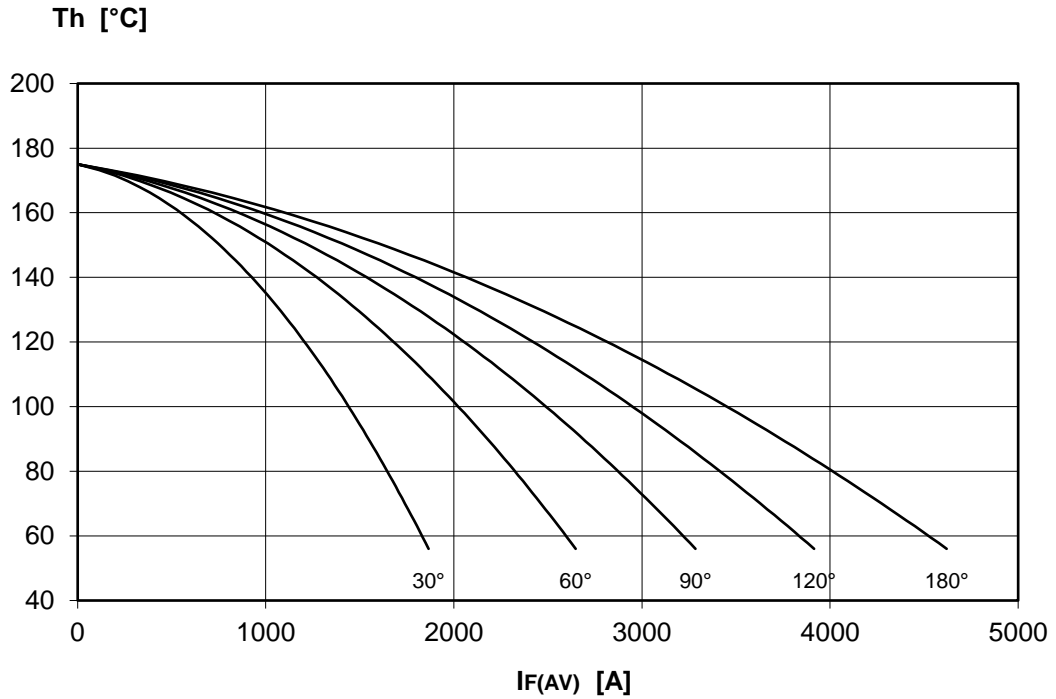

# AR649 RECTIFIER DIODE



FINAL SPECIFICATION Mar. 17 - Issue: 4

FORWARD CHARACTERISTIC  
T<sub>j</sub> = 175 °C

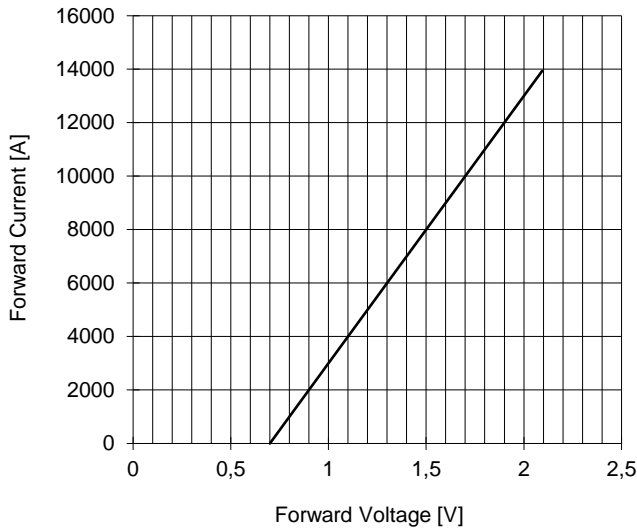

SURGE CHARACTERISTIC  
T<sub>j</sub> = 175 °C

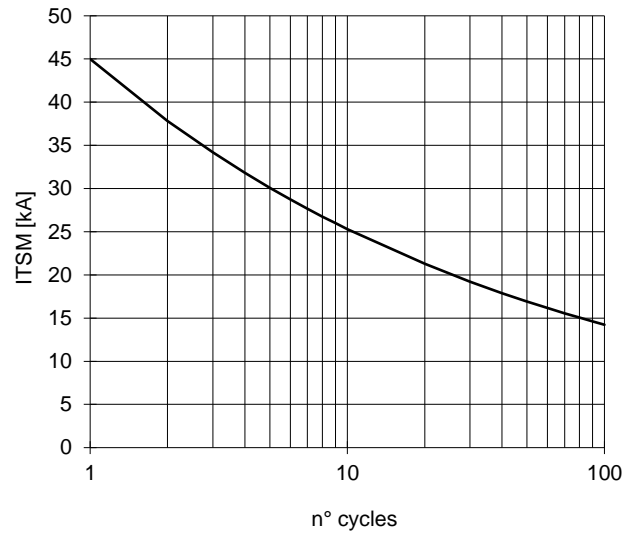

TRANSIENT THERMAL IMPEDANCE  
DOUBLE SIDE COOLED

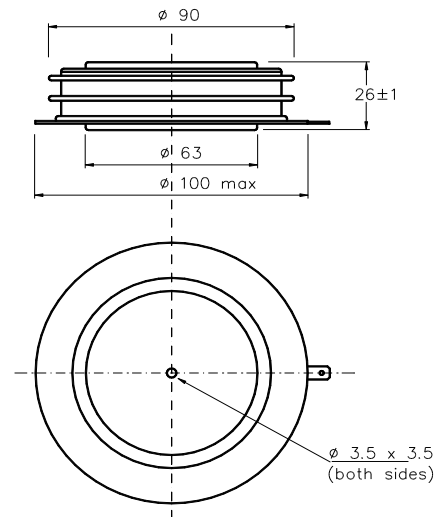
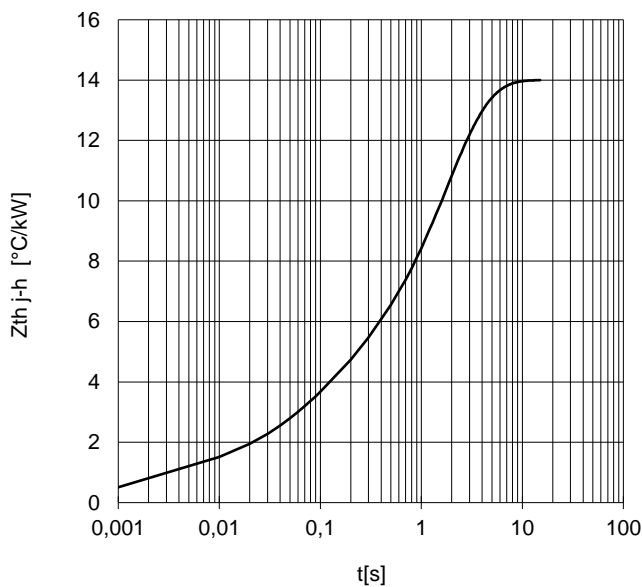

Dimensions  
in mm



Distributed by

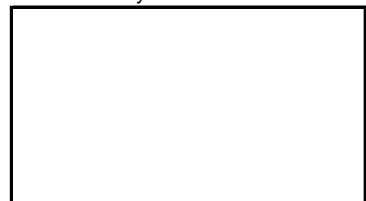

All the characteristics given in this data sheet are guaranteed only with uniform clamping force, cleaned and lubricated heatsink, surfaces with flatness < .03 mm and roughness < 2 μm.

In the interest of product improvement POSEICO SpA reserves the right to change any data given in this data sheet at any time without previous notice.

If not stated otherwise the maximum value of ratings (symbols over shaded background) and characteristics is reported.