

RECTIFIER DIODE

AR3009

Repetitive voltage up to **3200 V**
Mean forward current **2461 A**
Surge current **30,2 kA**

FINAL SPECIFICATION

Mar. 17 - Issue: 01

Symbol	Characteristic	Conditions	T _j [°C]	Value	Unit
BLOCKING					
V _{RRM}	Repetitive peak reverse voltage		160	3200	V
V _{RSM}	Non-repetitive peak reverse voltage		160	3300	V
I _{RRM}	Repetitive peak reverse current	V=VRRM	160	100	mA
CONDUCTING					
I _{F(AV)}	Mean forward current	180° sin ,50 Hz, Th=55°C, double side cooled		2461	A
I _{F(AV)}	Mean forward current	180° sin ,50 Hz, Tc=85°C, double side cooled		2339	A
I _{FSM}	Surge forward current	Sine wave, 10 ms without reverse voltage	160	30,2	kA
I ² t	I ² t			4560 x 10 ³	A ² s
V _{FM}	Forward voltage	Forward current = 2900 A	25	1,30	V
V _{F(TO)}	Threshold voltage		160	0,87	V
r _F	Forward slope resistance		160	0,127	mohm
SWITCHING					
t _{rr}	Reverse recovery time		160		μs
Q _{rr}	Reverse recovery charge				μC
I _{rr}	Peak reverse recovery current				A
MOUNTING					
R _{th(j-h)}	Thermal impedance, DC	Junction to heatsink, double side cooled		26	°C/kW
R _{th(c-h)}	Thermal impedance	Case to heatsink, double side cooled		6	°C/kW
T _j	Operating junction temperature			-30 / 160	°C
F	Mounting force			18.0 / 22.0	kN
	Mass			500	g
<p>ORDERING INFORMATION : AR3009 S 32</p> <p>standard specification <input type="checkbox"/> <input type="checkbox"/> VRRM/100</p>					

DISSIPATION CHARACTERISTICS

SQUARE WAVE

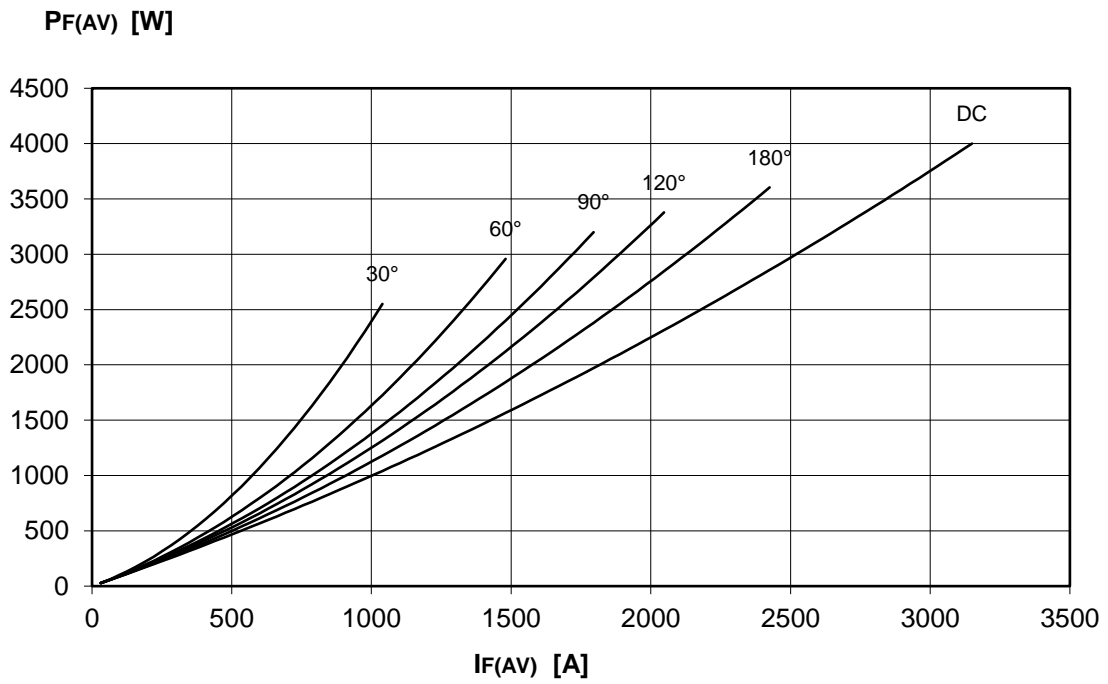
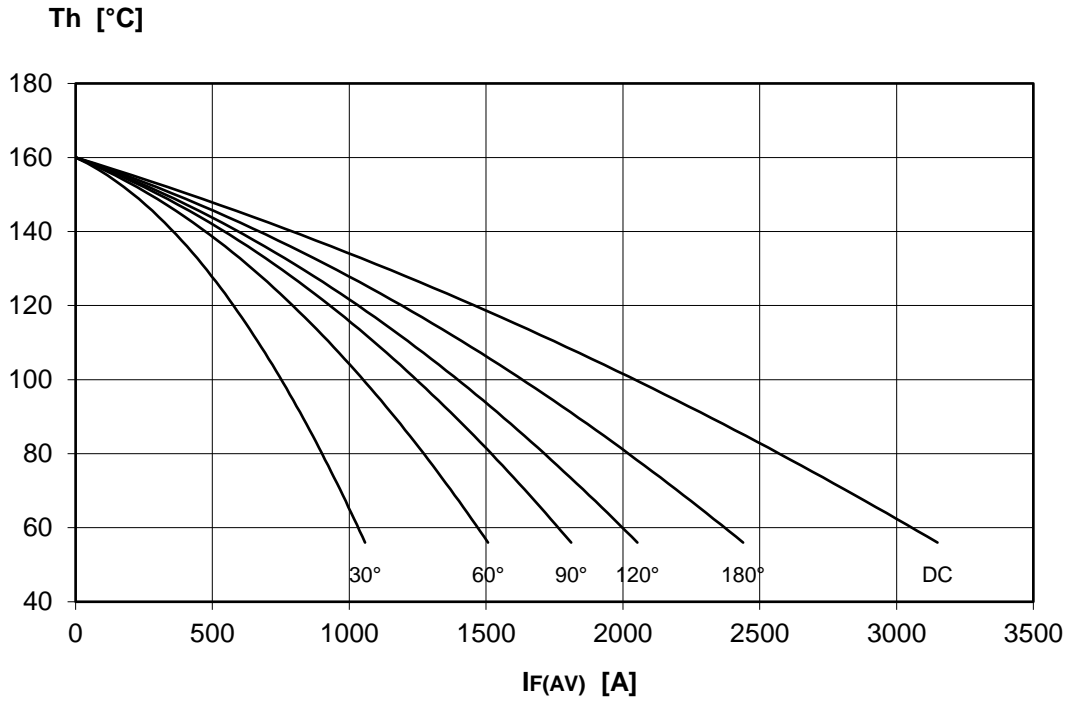

DISSIPATION CHARACTERISTICS

SINE WAVE

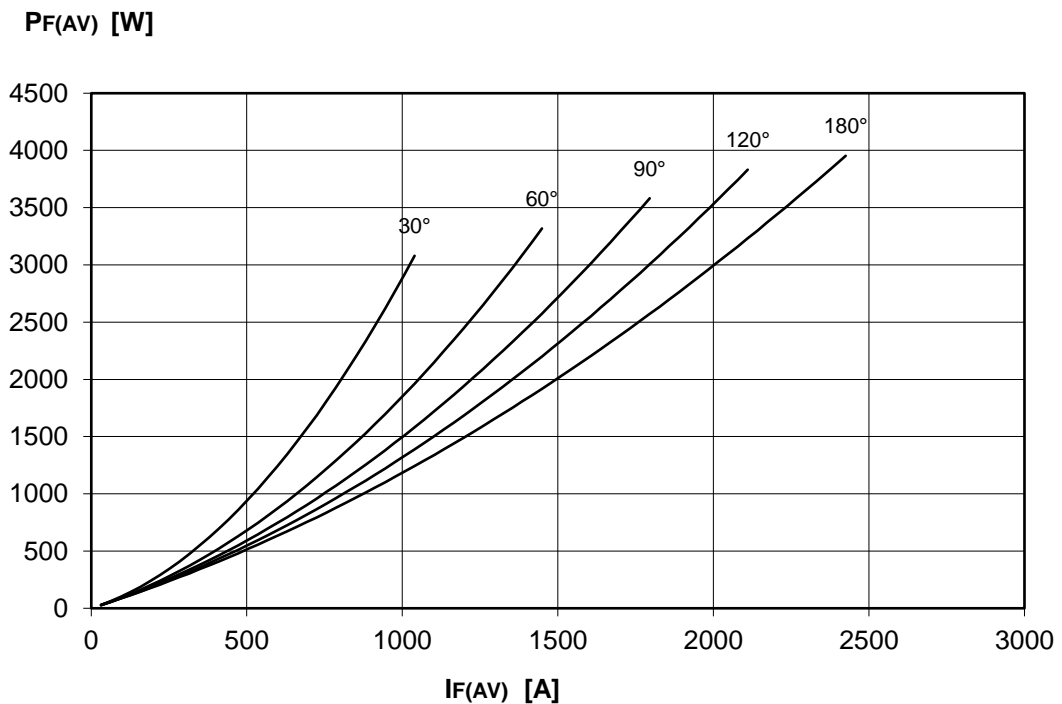
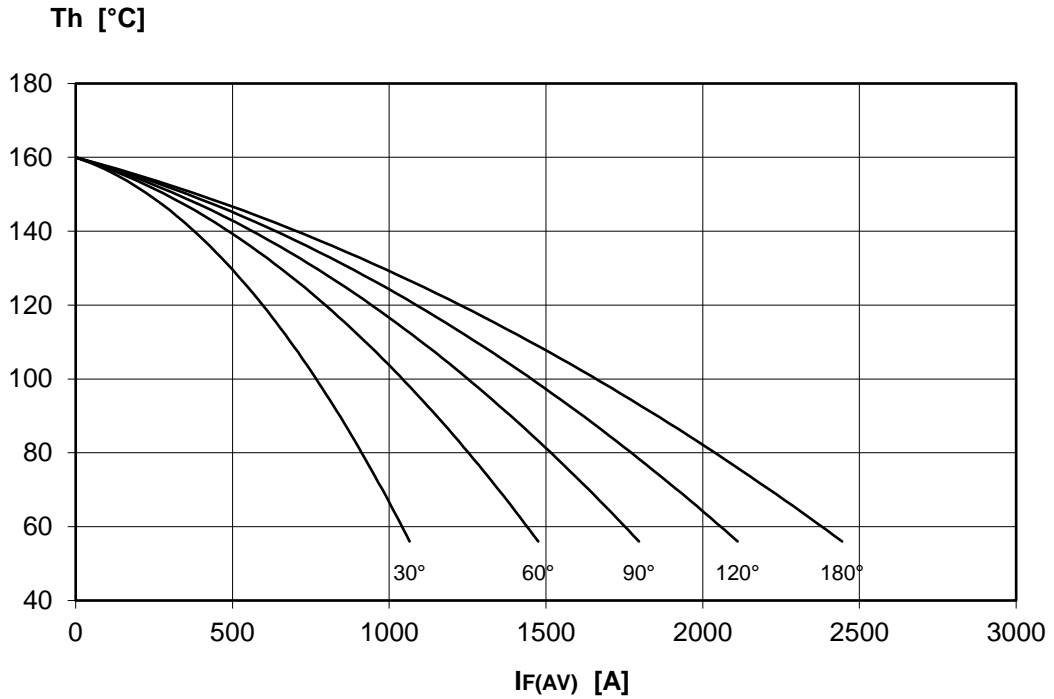

AR3009 RECTIFIER DIODE



FINAL SPECIFICATION Mar. 17 - Issue: 01

FORWARD CHARACTERISTIC
T_j = 160 °C

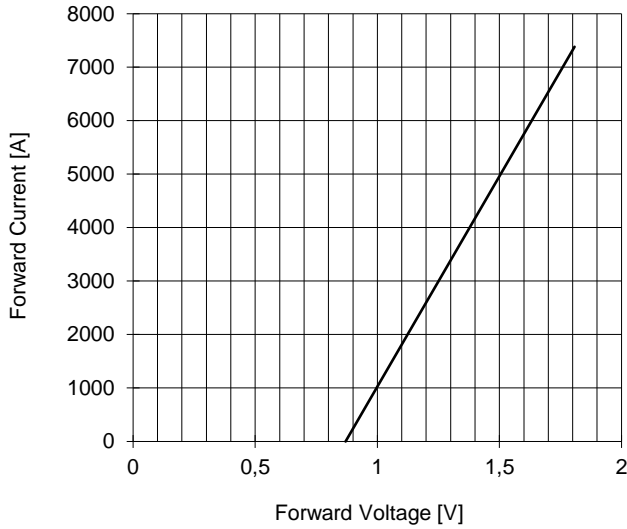

SURGE CHARACTERISTIC
T_j = 160 °C

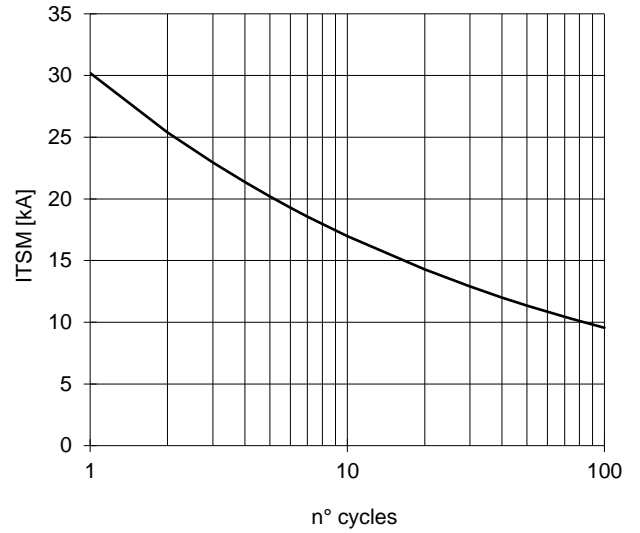

TRANSIENT THERMAL IMPEDANCE
DOUBLE SIDE COOLED

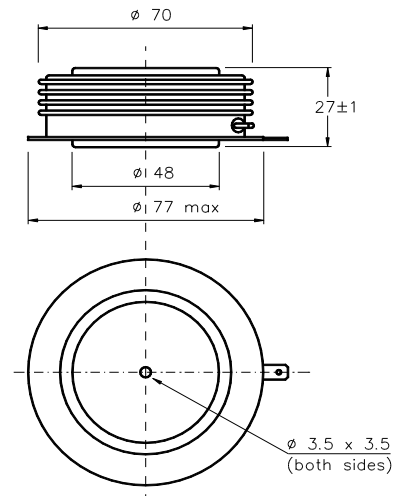
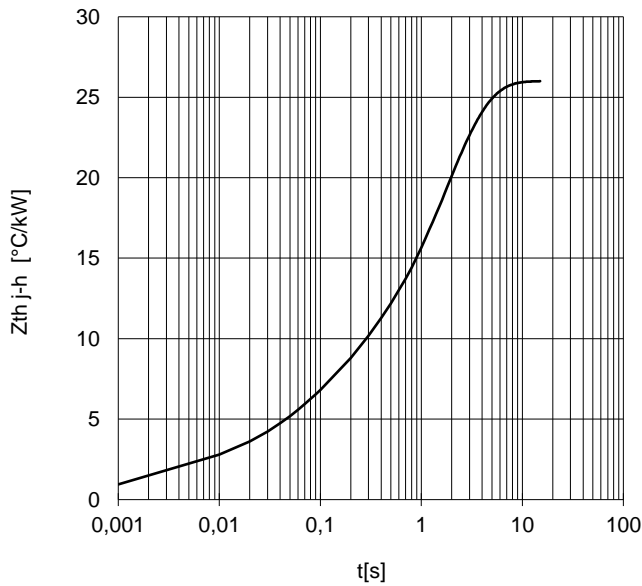

Dimensions in mm



All the characteristics given in this data sheet are guaranteed only with uniform clamping force, cleaned and lubricated heatsink, surfaces with flatness < .03 mm and roughness < 2 μm. In the interest of product improvement POSEICO SpA reserves the right to change any data given in this data sheet at any time without previous notice. If not stated otherwise the maximum value of ratings (symbols over shaded background) and characteristics is reported.

Distributed by

