

FAST SWITCHING THYRISTOR

ATF827

Repetitive voltage up to **1400 V**
Mean on-state current **900 A**
Surge current **10 kA**
Turn-off time **25 µs**

FINAL SPECIFICATION

gen 18 - ISSUE : 05

Symbol	Characteristic	Conditions	T _j [°C]	Value	Unit			
BLOCKING								
V _{RRM}	Repetitive peak reverse voltage		125	1400	V			
V _{RSM}	Non-repetitive peak reverse voltage		125	1500	V			
V _{DRM}	Repetitive peak off-state voltage		125	1400	V			
I _{RRM}	Repetitive peak reverse current	V=V _{RRM}	125	75	mA			
I _{DRM}	Repetitive peak off-state current	V=V _{DRM}	125	75	mA			
CONDUCTING								
I _{T(AV)}	Mean on-state current	180° sin, 50 Hz, Th=55°C, double side cooled		900	A			
I _{T(AV)}	Mean on-state current	180° sin, 1 kHz, Th=55°C, double side cooled		835	A			
I _{TSM}	Surge on-state current, non repetitive	sine wave, 10 ms	125	10	kA			
I ² t	I ² t	without reverse voltage		500 x1E3	A ² s			
V _T	On-state voltage	On-state current = 1600 A	25	2	V			
V _{T(TO)}	Threshold voltage		125	1,32	V			
r _T	On-state slope resistance		125	0,350	mohm			
SWITCHING								
di/dt	Critical rate of rise of on-state current, min	From 75% V _{DRM} up to 1200 A, gate 20V 10 ohm	125	400	A/µs			
dv/dt	Critical rate of rise of off-state voltage, min	Linear ramp up to 70% of V _{DRM}	125	600	V/µs			
t _d	Gate controlled delay time, typical	V _D =100V, gate source 20V, 10 ohm , tr=1 µs	25	0,6	µs			
t _q	Circuit commutated turn-off time	di/dt = 20 A/µs, I = 400 A dv/dt = 200 V/µs , up to 75% V _{DRM}	125	25	µs			
Q _{rr}	Reverse recovery charge	di/dt = 60 A/µs, I = 1000 A	125	330	µC			
I _{rr}	Peak reverse recovery current	V _R = 50 V		168	A			
I _H	Holding current, typical	V _D =5V, gate open circuit	25	45	mA			
I _L	Latching current, typical	V _D =5V, tp=30µs	25	70	mA			
GATE								
V _{GT}	Gate trigger voltage	V _D =5V	25	3,5	V			
I _{GT}	Gate trigger current	V _D =5V	25	350	mA			
V _{GD}	Non-trigger gate voltage, min.	V _D =V _{DRM}	125	0,25	V			
V _{FGM}	Peak gate voltage (forward)		25	30	V			
I _{FGM}	Peak gate current		25	10	A			
V _{RGM}	Peak gate voltage (reverse)		25	5	V			
P _{GM}	Peak gate power dissipation	Pulse width 100 µs	25	150	W			
P _{G(AV)}	Average gate power dissipation		25	3	W			
MOUNTING								
R _{th(j-h)}	Thermal impedance, DC	Junction to heatsink, double side cooled		37	°C/kW			
T _j	Operating junction temperature			-30 / 125	°C			
F	Mounting force			11.0 / 13.0	kN			
	Mass			320	g			
<p>ORDERING INFORMATION : ATF827 S 14 L _____ tq code standard specification _____ V_{DRM}&V_{RRM}/100</p>								
			tq code	D 10 µs	C 12 µs	B 15 µs	A 20 µs	L 25 µs
				M 30 µs	N 35 µs	P 40 µs	R 45 µs	S 50 µs
				T 60 µs	U 70 µs	W 80 µs	X 100µs	Y 150µs

ON-STATE CHARACTERISTIC
T_j = 125 °C

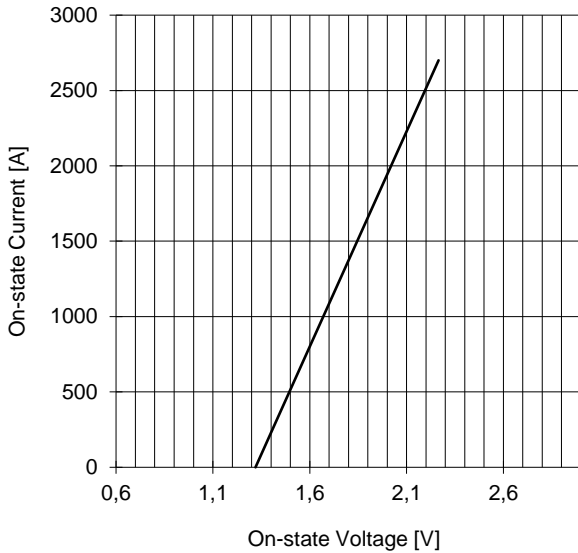

SURGE CHARACTERISTIC
T_j = 125 °C

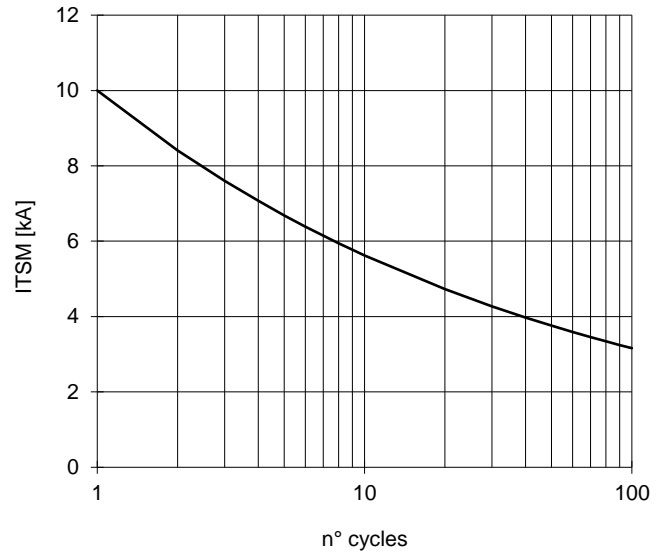

TRANSIENT THERMAL IMPEDANCE
DOUBLE SIDE COOLED

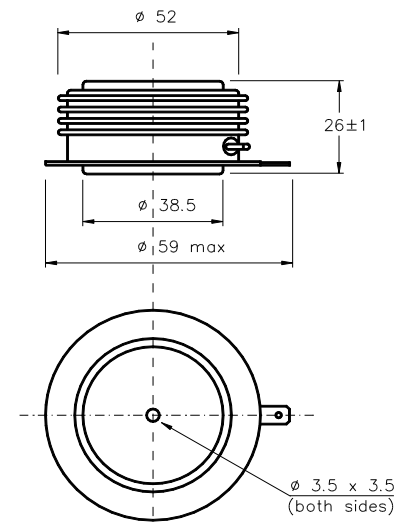
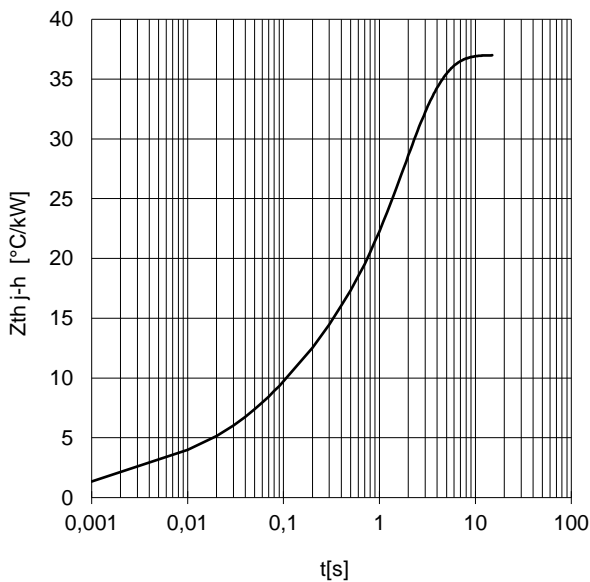

Dimensions
in mm



Cathode terminal type DIN 46244 - A 4.8 - 0.8

Gate terminal type AMP 60598 - 1

All the characteristics given in this data sheet are guaranteed only with uniform clamping force, cleaned and lubricated heatsink, surfaces with flatness < .03 mm and roughness < 2 μm.

In the interest of product improvement POSEICO SpA reserves the right to change any data given in this data sheet at any time without previous notice.

If not stated otherwise the maximum value of ratings (symbols over shaded background) and characteristics is reported.

Distributed by

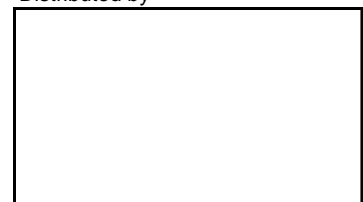

SWITCHING CHARACTERISTICS

REVERSE RECOVERY CHARGE
 $T_j = 125\text{ }^\circ\text{C}$

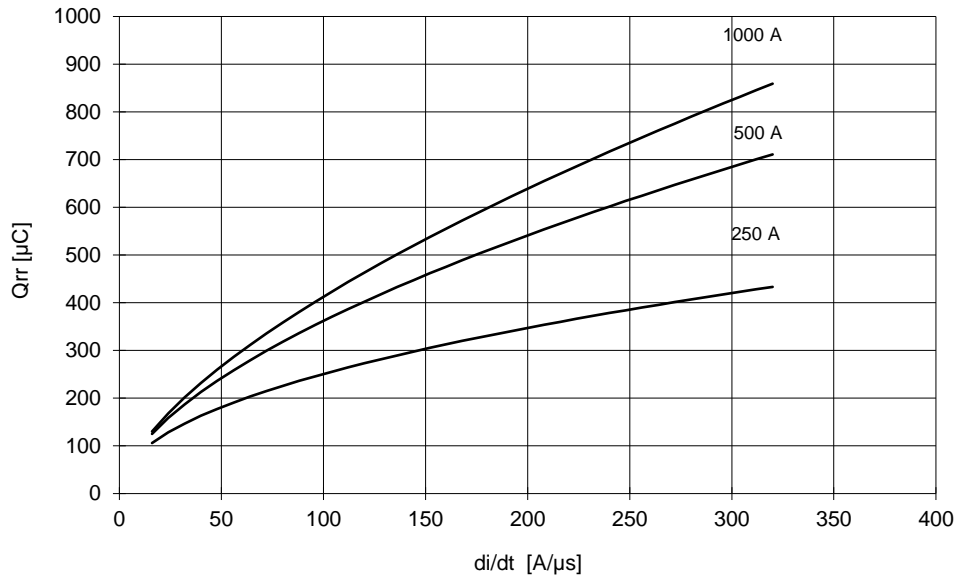

REVERSE RECOVERY CURRENT
 $T_j = 125\text{ }^\circ\text{C}$

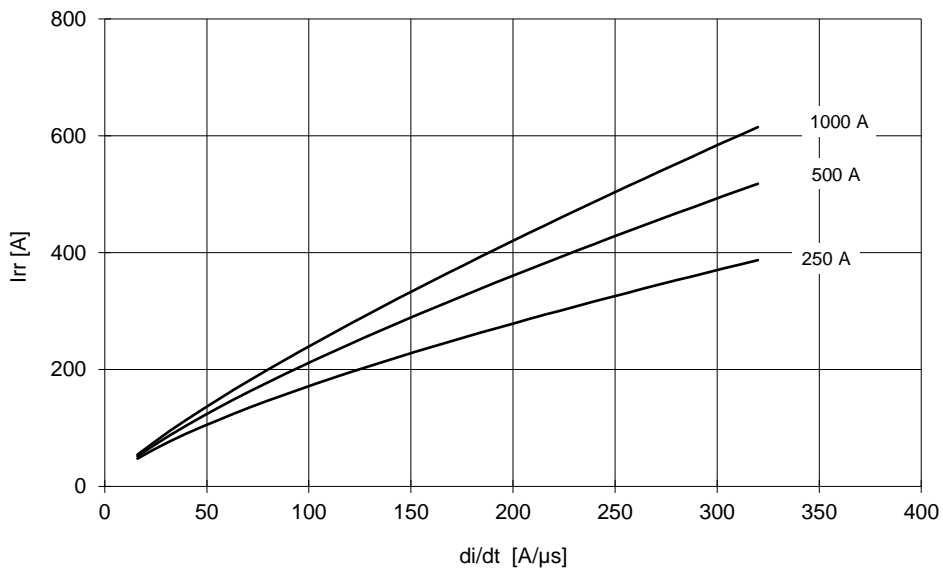

$$t_a = I_{rr} / (di/dt) \quad t_b = t_{rr} - t_a$$

$$\text{Softness (s factor)} \quad s = t_b / t_a$$

$$\text{Energy dissipation during recovery } E_r = V_r \cdot (Q_{rr} - I_{rr} \cdot t_a / 2)$$

