

FAST RECOVERY DIODE

ARF674

Repetitive voltage up to

4500 V

Mean forward current

944 A

Surge current

15 kA
FINAL SPECIFICATION

June 17 - Issue: 4

Symbol	Characteristic	Conditions	T _j [°C]	Value	Unit
BLOCKING					
V _{RRM}	Repetitive peak reverse voltage		125	4500	V
V _{RSM}	Non-repetitive peak reverse voltage		125	4600	V
I _{RRM}	Repetitive peak reverse current	V=VRRM	125	80	mA
CONDUCTING					
I _{F(AV)}	Mean forward current	180° sin, 50 Hz, Th=55°C, double side cooled		944	A
I _{F(AV)}	Mean forward current	180°square, 50 Hz, Th=55°C, double side cooled		941	A
I _{FSM}	Surge forward current	Sine wave, 10 ms riapped reverse voltage up to 50% VRSM	125	15	kA
I ² t	I ² t			1125 x 10 ³	A ² s
V _{FM}	Forward voltage	Forward current = 1570 A	25	3,00	V
V _{F(TO)}	Threshold voltage		125	1,90	V
r _F	Forward slope resistance		125	0,700	mohm
SWITCHING					
t _{rr}	Reverse recovery time	IF= 500A	125	8	μs
Q _{rr}	Reverse recovery charge	di/dt= 30 A/μs		600	μC
I _{rr}	Peak reverse recovery current	VR= 100V		150	A
s	Softness (s-factor), min			0,4	
V _{FR}	Peak forward recovery	di/dt = 400 A/μs	140	42	V
MOUNTING					
R _{th(j-h)}	Thermal impedance, DC	Junction to heatsink, double side cooled		21,0	°C/kW
R _{th(c-h)}	Thermal impedance	Case to heatsink, double side cooled		4,0	°C/kW
T _j	Operating junction temperature			-30 / 125	°C
F	Mounting force			22.0 / 24.5	kN
	Mass			520	g

ORDERING INFORMATION : ARF674 S 45

 standard specification VRRM/100

DISSIPATION CHARACTERISTICS

SQUARE WAVE (50Hz)

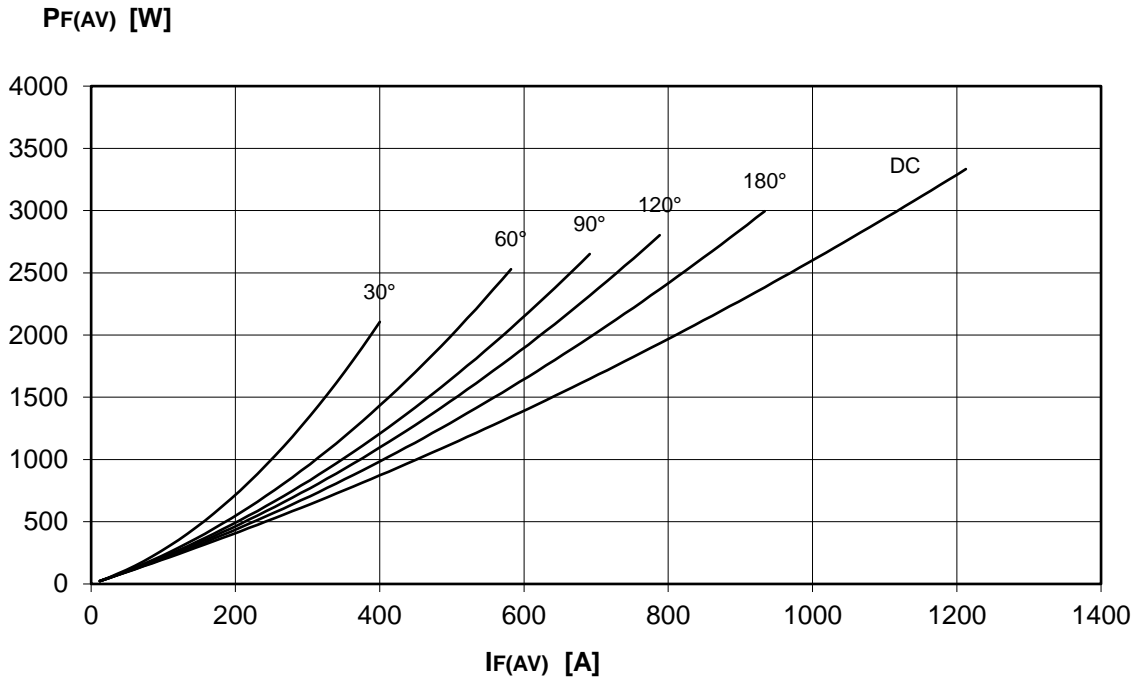

SINE WAVE (50Hz)

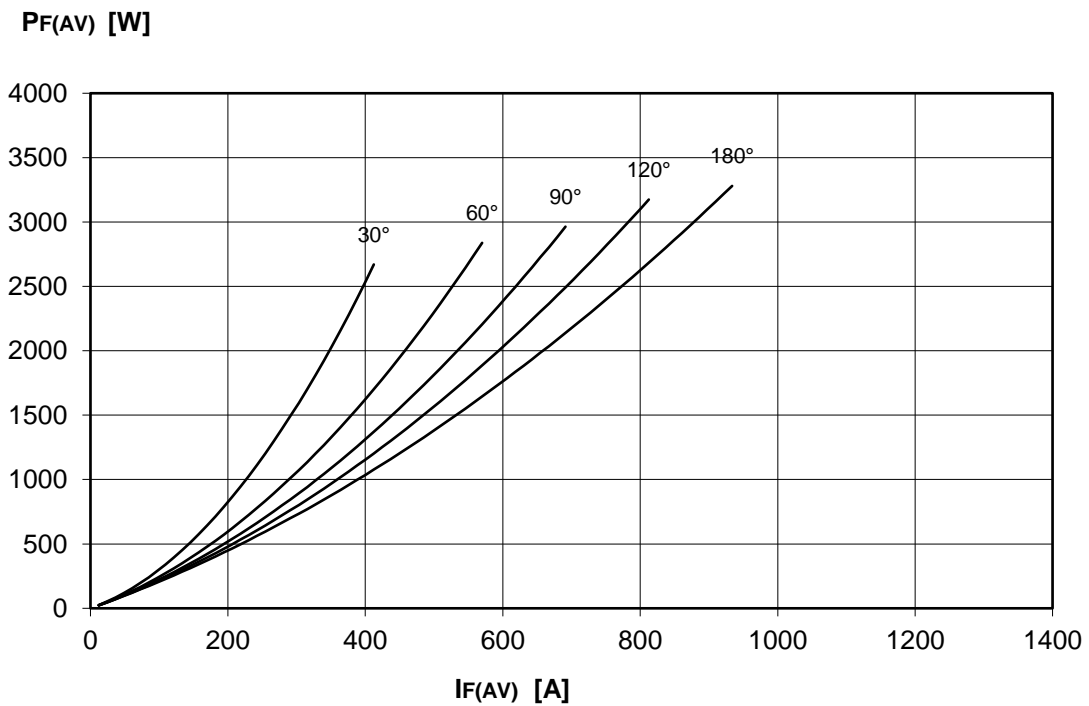

FORWARD RECOVERY VOLTAGE

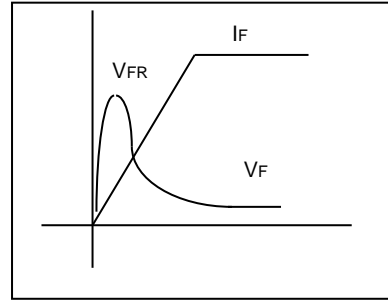
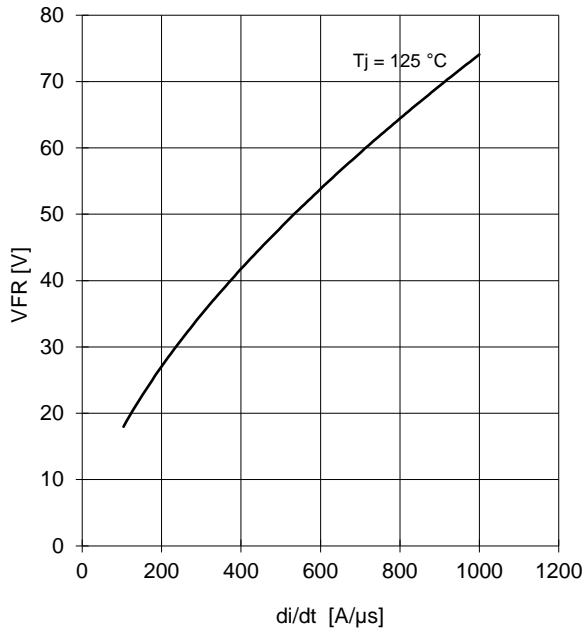

REVERSE RECOVERY CHARGE Tj = 125 °C

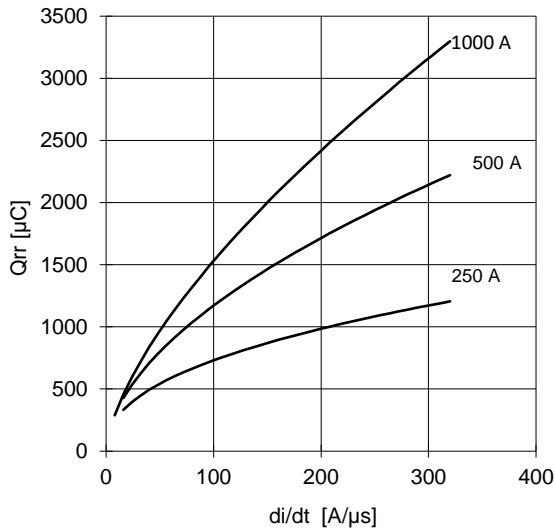

REVERSE RECOVERY CURRENT Tj = 125 °C

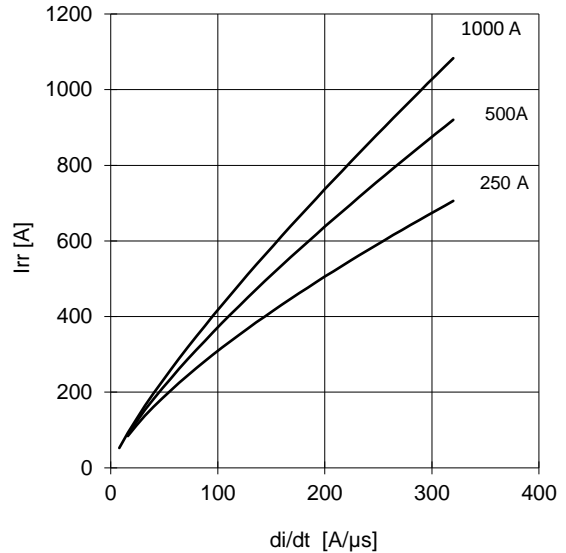

$$t_a = I_{rr} / (di/dt) \quad t_b = t_{rr} - t_a$$

$$\text{Softness (s factor)} \quad s = t_b / t_a$$

$$\text{Energy dissipation during recovery } E_r = V_r \cdot (Q_{rr} - I_{rr} \cdot t_a / 2)$$

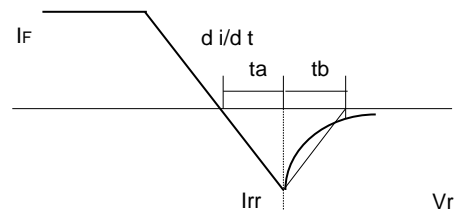

ARF674 FAST RECOVERY DIODE



FINAL SPECIFICATION June 17 - Issue: 4

FORWARD CHARACTERISTIC
T_j = 125 °C

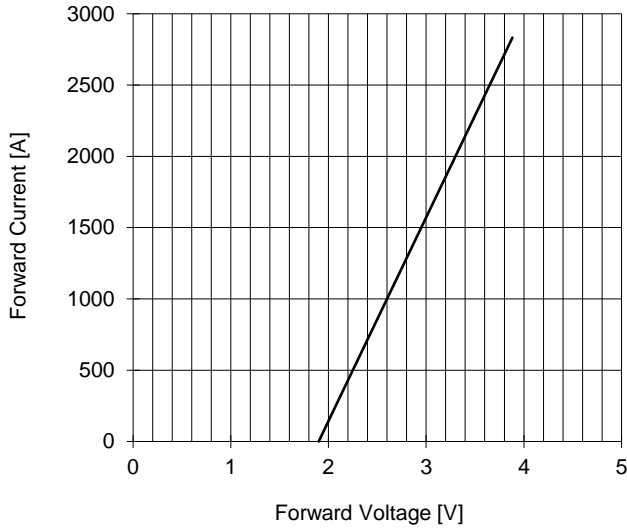

SURGE CHARACTERISTIC
T_j = 125 °C

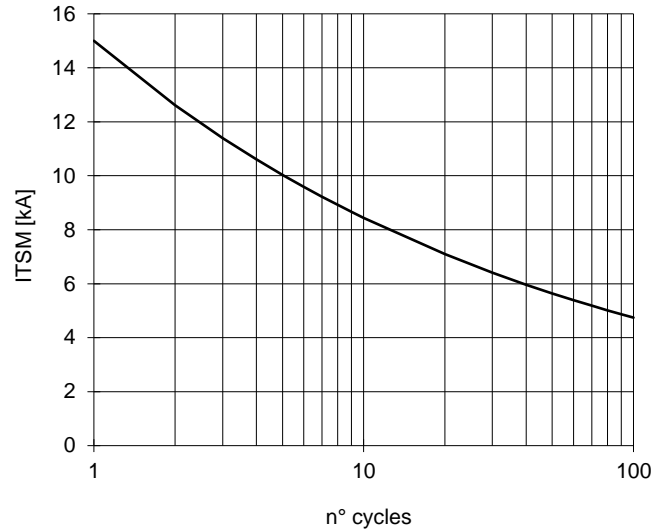

TRANSIENT THERMAL IMPEDANCE
DOUBLE SIDE COOLED

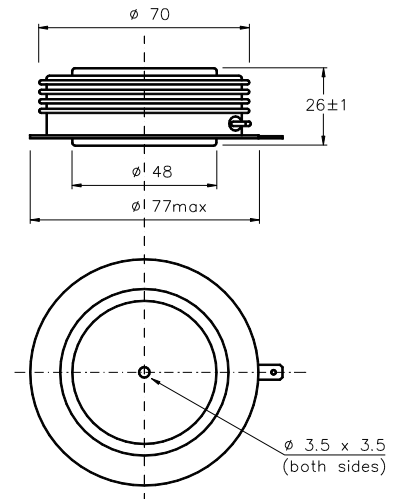
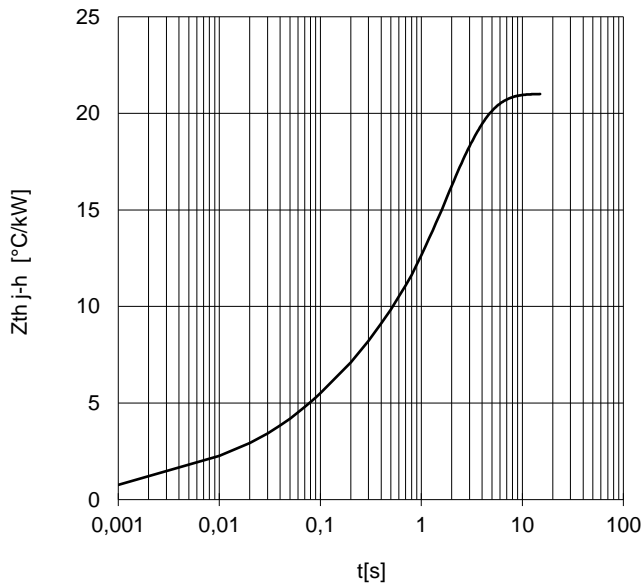

Dimensions
in mm



Distributed by

All the characteristics given in this data sheet are guaranteed only with uniform clamping force, cleaned and lubricated heatsink, surfaces with flatness < .03 mm and roughness < 2 μ m. In the interest of product improvement POSEICO SpA reserves the right to change any data given in this data sheet at any time without previous notice. If not stated otherwise the maximum value of ratings (symbols over shaded background) and characteristics is reported.

