

FAST RECOVERY DIODE

ARF526

Repetitive voltage up to	1600 V
Mean forward current	1348 A
Surge current	20 kA

FINAL SPECIFICATION

June 17 - Issue: 3

Symbol	Characteristic	Conditions	T _j [°C]	Value	Unit
BLOCKING					
V _{RRM}	Repetitive peak reverse voltage		125	1600	V
V _{RSM}	Non-repetitive peak reverse voltage		125	1700	V
I _{RRM}	Repetitive peak reverse current	V=VRRM	125	50	mA
CONDUCTING					
I _{F(AV)}	Mean forward current	180° sin, 50 Hz, Th=55°C, double side cooled		1348	A
I _{F(AV)}	Mean forward current	180°square, 50 Hz, Th=55°C, double side cooled		1351	A
I _{FSM}	Surge forward current	Sine wave, 10 ms riapped reverse voltage up to 50% VRSM	125	20	kA
I ² t	I ² t			2000 x 10 ³	A ² s
V _{FM}	Forward voltage	Forward current = 2000 A	25	1,60	V
V _{F(TO)}	Threshold voltage		125	1,00	V
r _F	Forward slope resistance		125	0,300	mohm
SWITCHING					
t _{rr}	Reverse recovery time	IF= 1000A di/dt= 100 A/μs VR= 50V	125	3,5	μs
Q _{rr}	Reverse recovery charge			250	μC
I _{rr}	Peak reverse recovery current			145	A
s	Softness (s-factor), min			0,5	
V _{FR}	Peak forward recovery	di/dt = 100 A/μs	125	15	V
MOUNTING					
R _{th(j-h)}	Thermal impedance, DC	Junction to heatsink, double side cooled		26,0	°C/kW
R _{th(c-h)}	Thermal impedance	Case to heatsink, double side cooled		6,0	°C/kW
T _j	Operating junction temperature			-30 / 125	°C
F	Mounting force			18.0 / 20.0	kN
	Mass			500	g

ORDERING INFORMATION : ARF526 S 16

 standard specification VRRM/100

DISSIPATION CHARACTERISTICS

SQUARE WAVE (50Hz)

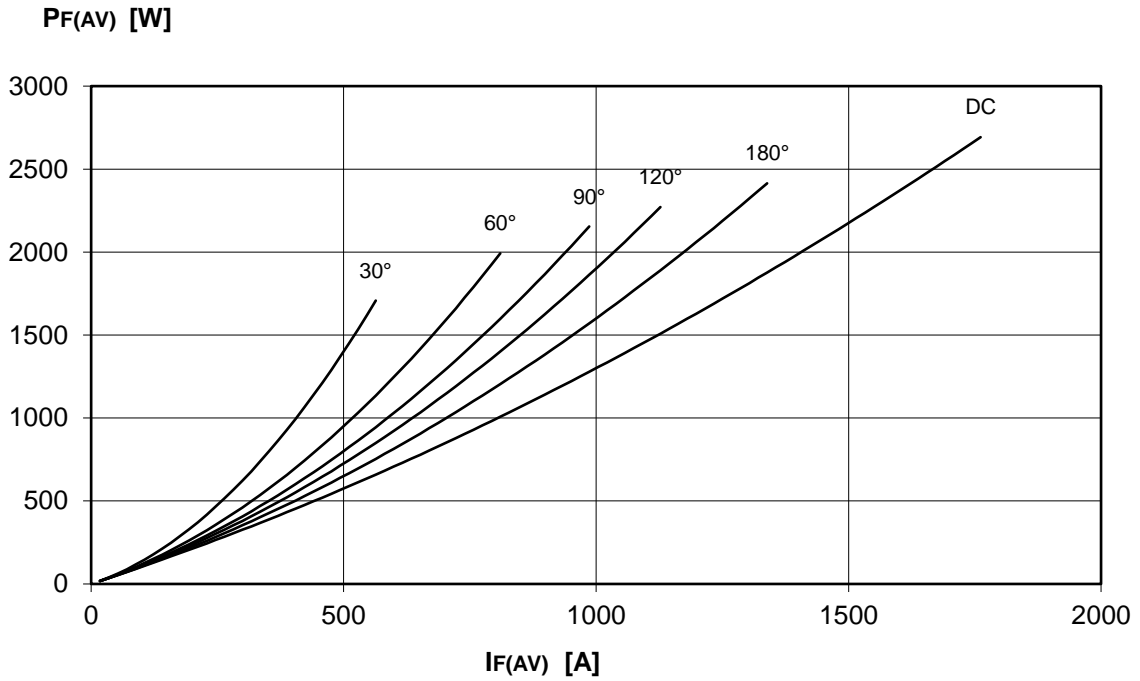

SINE WAVE (50Hz)

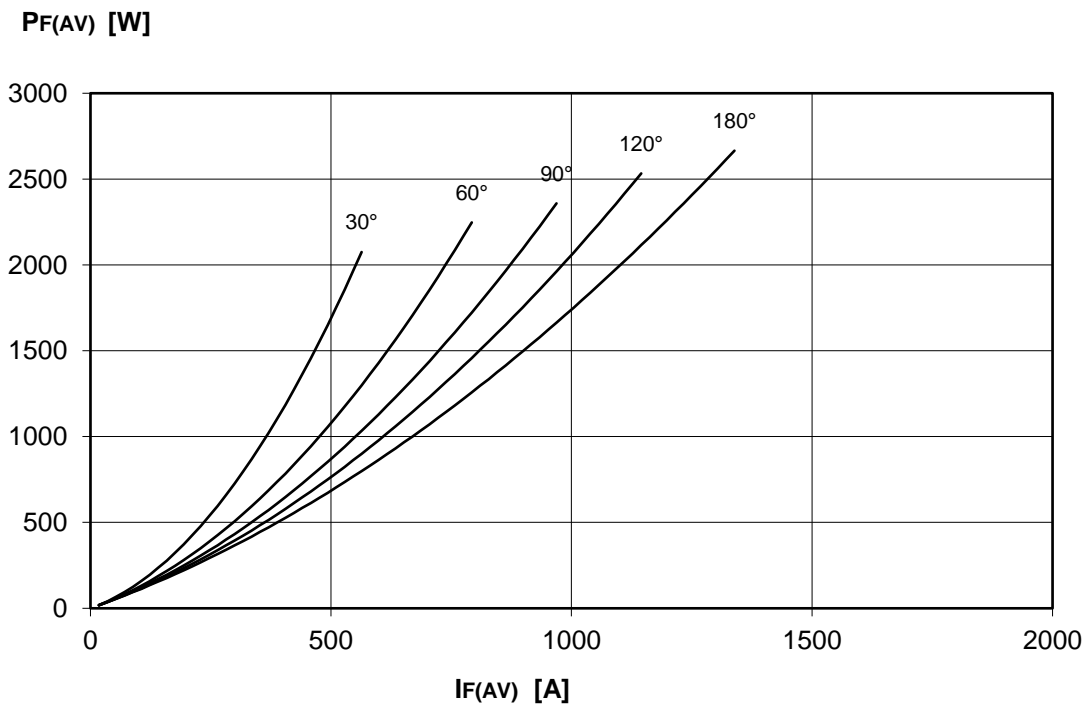

ARF526 FAST RECOVERY DIODE



FINAL SPECIFICATION June 17 - Issue: 3

FORWARD RECOVERY VOLTAGE

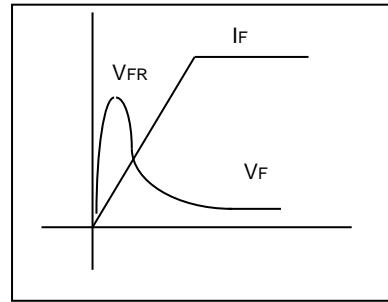
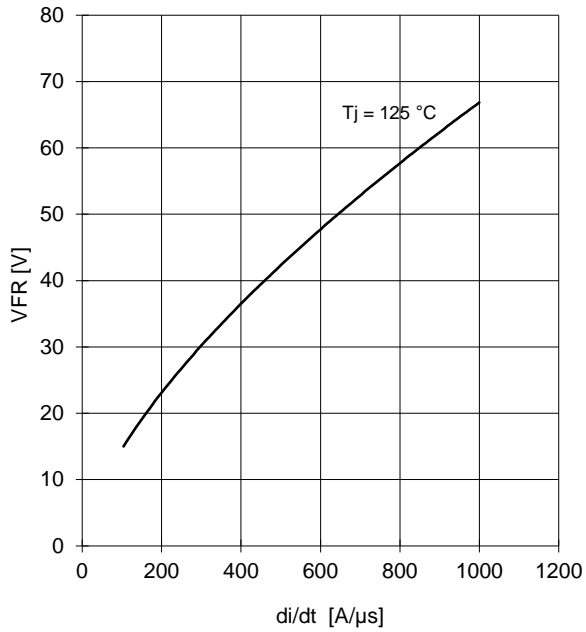

REVERSE RECOVERY CHARGE Tj = 125 °C

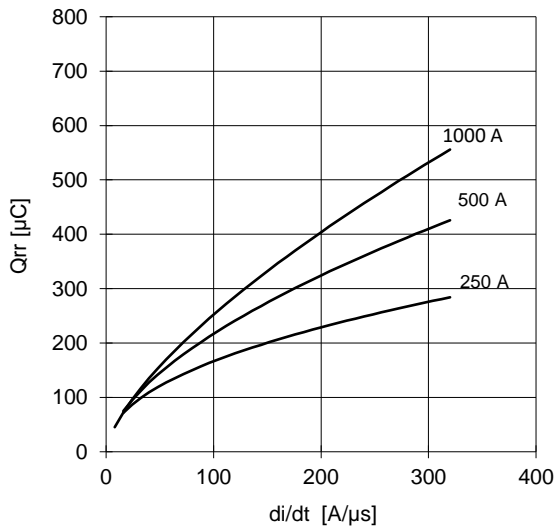

REVERSE RECOVERY CURRENT Tj = 125 °C

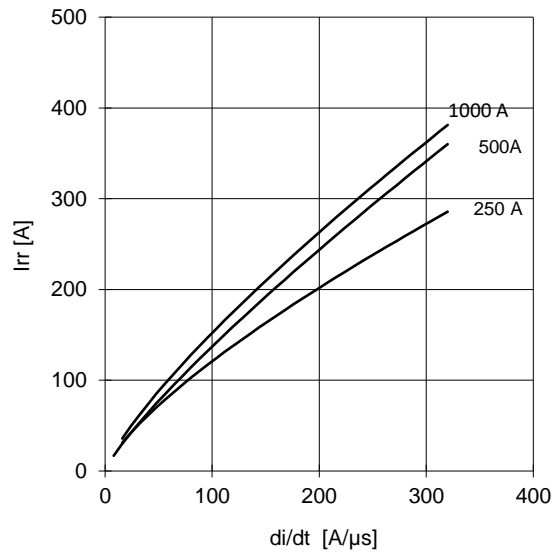

$$t_a = I_{rr} / (di/dt) \quad t_b = t_{rr} - t_a$$

$$\text{Softness (s factor)} \quad s = t_b / t_a$$

$$\text{Energy dissipation during recovery } E_r = V_r \cdot (Q_{rr} - I_{rr} \cdot t_a / 2)$$

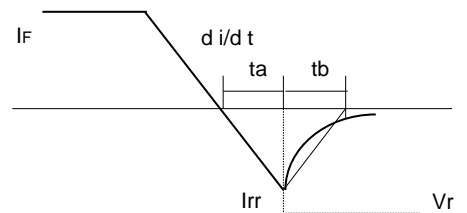

ARF526 FAST RECOVERY DIODE



FINAL SPECIFICATION June 17 - Issue: 3

FORWARD CHARACTERISTIC
T_j = 125 °C

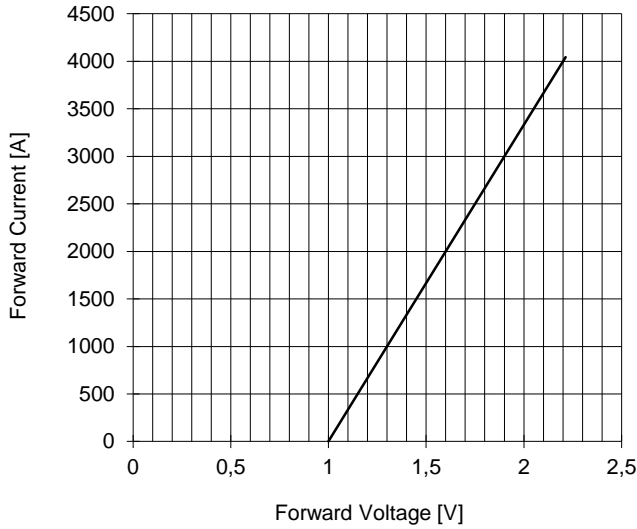

SURGE CHARACTERISTIC
T_j = 125 °C

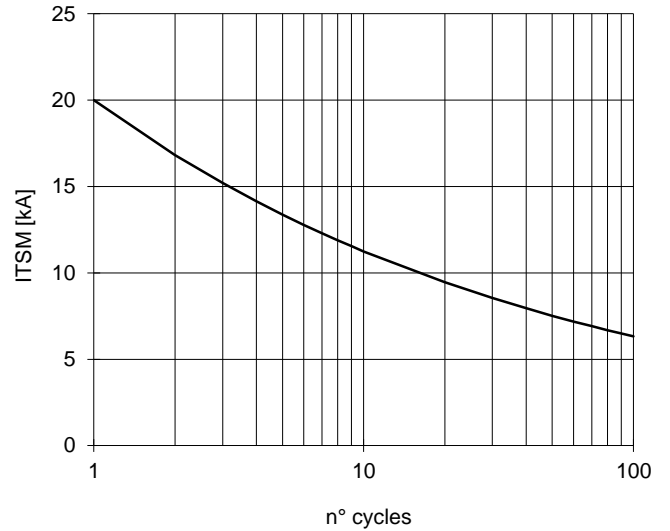

TRANSIENT THERMAL IMPEDANCE
DOUBLE SIDE COOLED

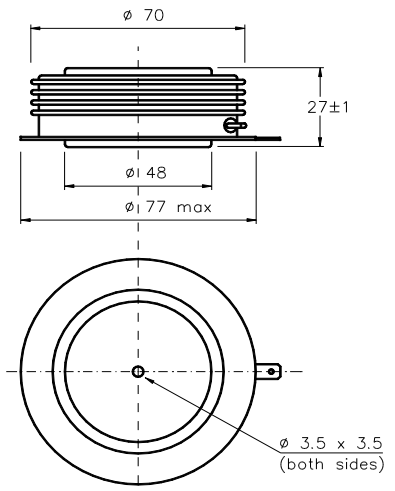
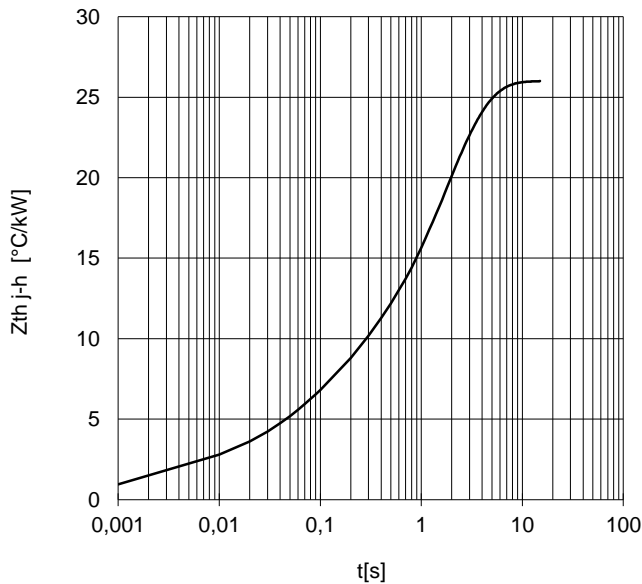

Dimensions
in mm



Distributed by

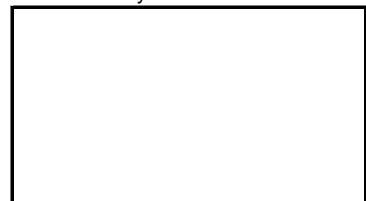

All the characteristics given in this data sheet are guaranteed only with uniform clamping force, cleaned and lubricated heatsink, surfaces with flatness < .03 mm and roughness < 2 μm. In the interest of product improvement POSEICO SpA reserves the right to change any data given in this data sheet at any time without previous notice. If not stated otherwise the maximum value of ratings (symbols over shaded background) and characteristics is reported.