

FAST RECOVERY DIODE

ARF261

Repetitive voltage up to

3300 V

Mean forward current

124 A

Surge current

3, kA

FINAL SPECIFICATION

June 17 - Issue: 3

Symbol	Characteristic	Conditions	T _j [°C]	Value	Unit
BLOCKING					
V _{RRM}	Repetitive peak reverse voltage		125	3300	V
V _{RSM}	Non-repetitive peak reverse voltage		125	3400	V
I _{RRM}	Repetitive peak reverse current	V=VRRM	125	50	mA
CONDUCTING					
I _{F(AV)}	Mean forward current	180° sin, 50 Hz, Th=55°C, double side cooled		124	A
I _{F(AV)}	Mean forward current	180°square, 50 Hz, Th=55°C, double side cooled		126	A
I _{FSM}	Surge forward current	Sine wave, 10 ms without reverse voltage	125	3	kA
I ² t	I ² t			45 x 10 ³	A ² s
V _{FM}	Forward voltage	Forward current = 100 A	125	3,50	V
V _{F(TO)}	Threshold voltage		125	2,30	V
r _F	Forward slope resistance		125	12,00	mohm
SWITCHING					
t _{rr}	Reverse recovery time	IF= 200A	125	1	μs
Q _{rr}	Reverse recovery charge	di/dt= 100 A/μs		45	μC
I _{rr}	Peak reverse recovery current	VR= 50V		90	A
s	Softness (s-factor), min			0,44	
V _{FR}	Peak forward recovery	di/dt = 150 A/μs		14	V
MOUNTING					
R _{th(j-h)}	Thermal impedance, DC	Junction to heatsink, double side cooled		95,0	°C/kW
R _{th(c-h)}	Thermal impedance	Case to heatsink, double side cooled		20,0	°C/kW
T _j	Operating junction temperature			-30 / 125	°C
F	Mounting force			4.5 / 5.0	kN
	Mass			55	g

ORDERING INFORMATION : ARF261 S 33

standard specification VRRM/100

DISSIPATION CHARACTERISTICS

SQUARE WAVE (50Hz)

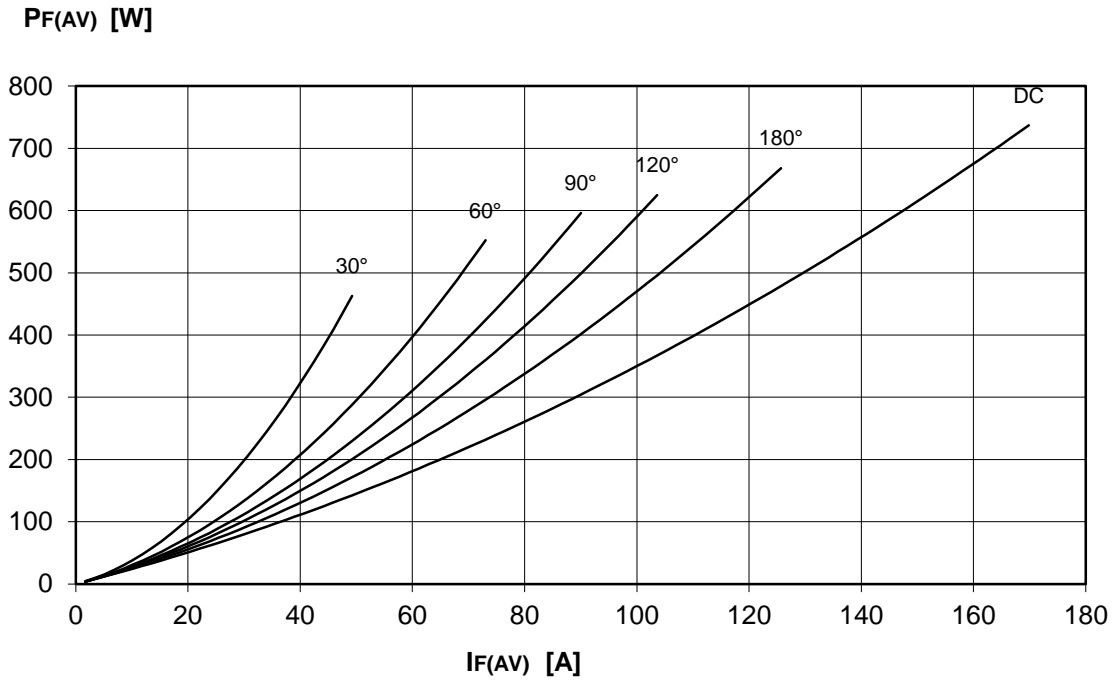

SINE WAVE (50Hz)

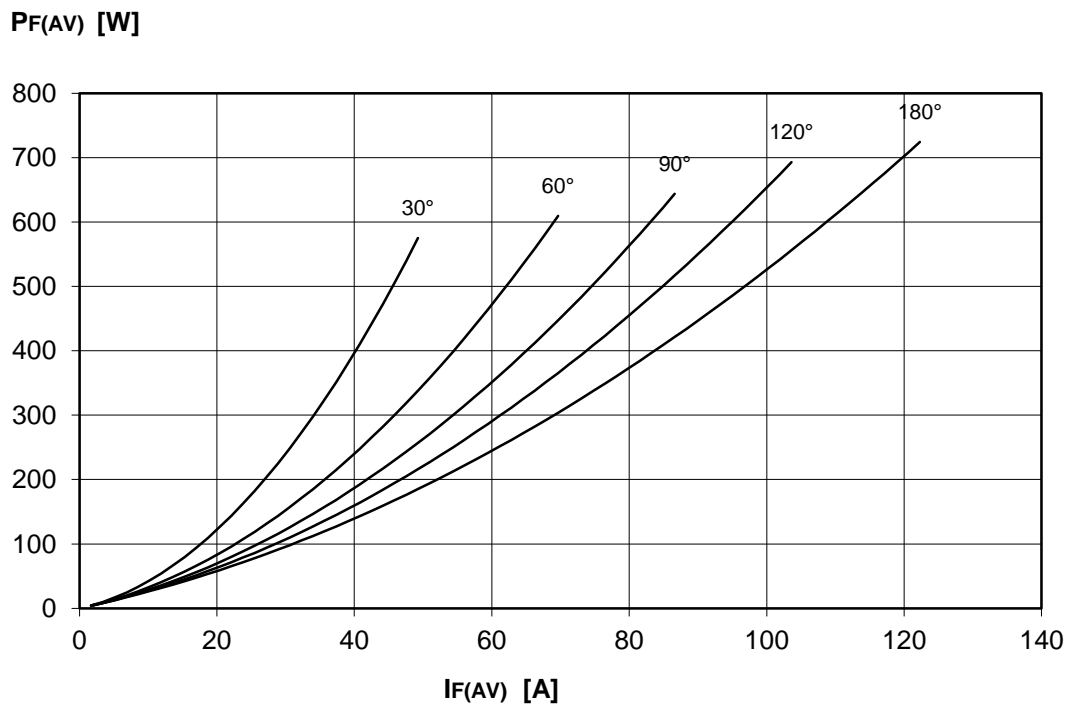

FORWARD RECOVERY VOLTAGE

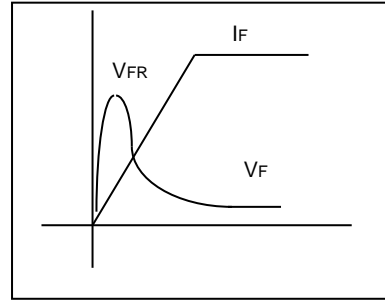
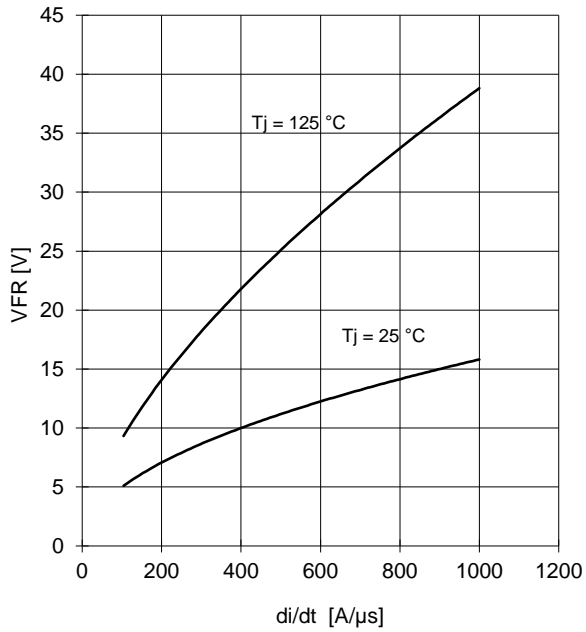

REVERSE RECOVERY CHARGE Tj = 125 °C

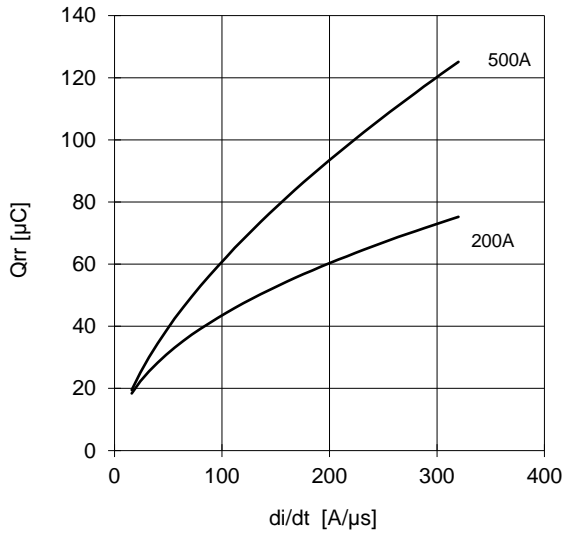

REVERSE RECOVERY CURRENT Tj = 125 °C

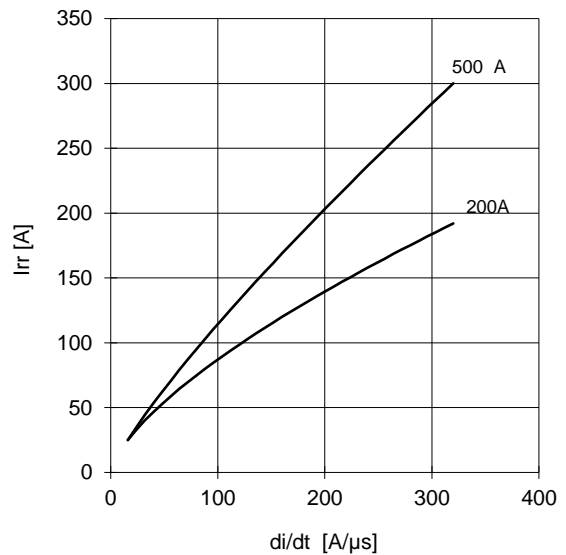

$$t_a = I_{rr} / (di/dt) \quad t_b = t_{rr} - t_a$$

$$\text{Softness (s factor)} \quad s = t_b / t_a$$

$$\text{Energy dissipation during recovery } E_r = V_r \cdot (Q_{rr} - I_{rr} \cdot t_a / 2)$$

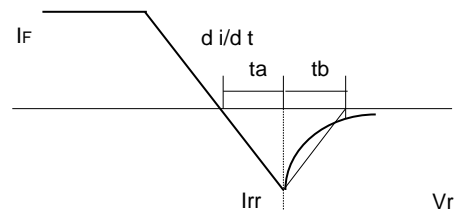

ARF261 FAST RECOVERY DIODE



FINAL SPECIFICATION June 17 - Issue: 3

FORWARD CHARACTERISTIC
T_j = 125 °C

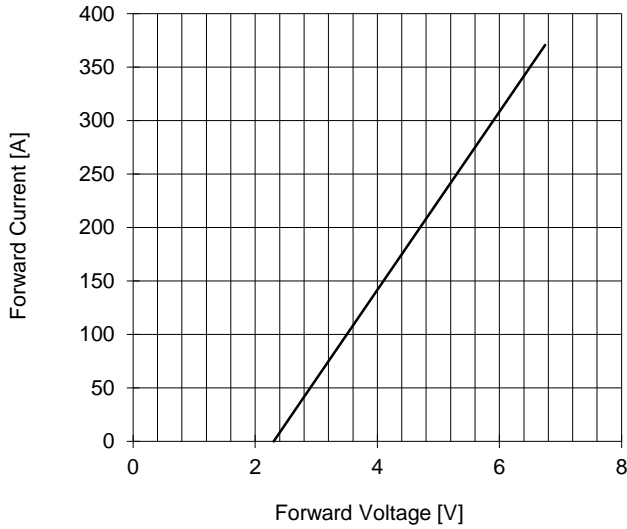

SURGE CHARACTERISTIC
T_j = 125 °C

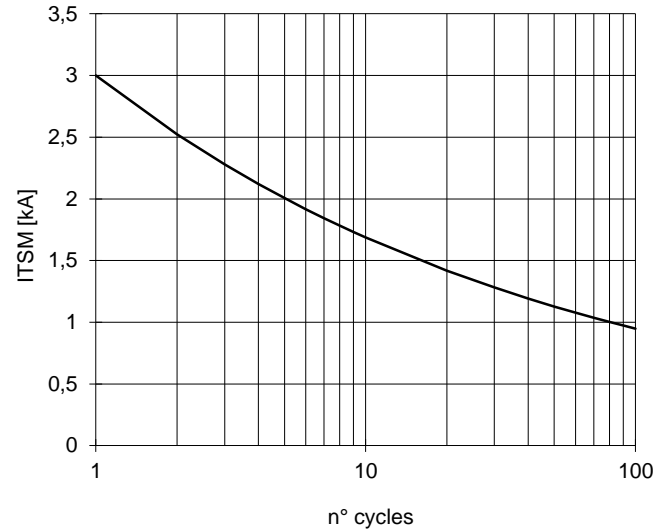

TRANSIENT THERMAL IMPEDANCE
DOUBLE SIDE COOLED

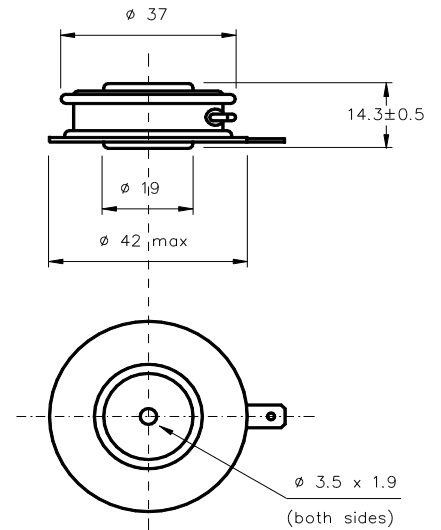
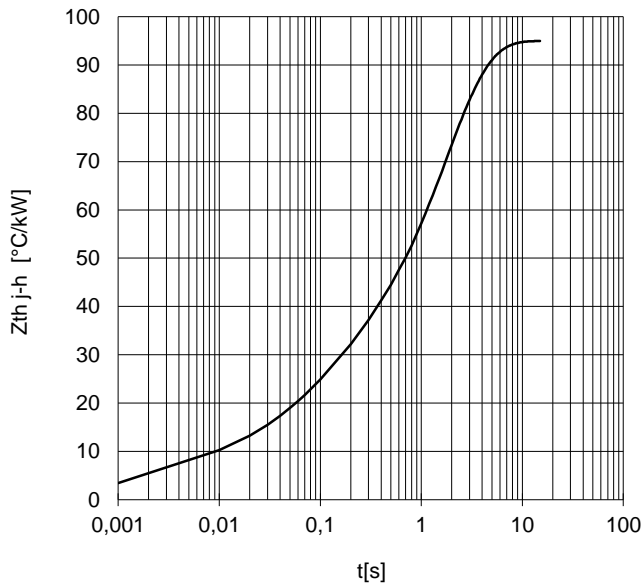

Dimensions
in mm



Distributed by

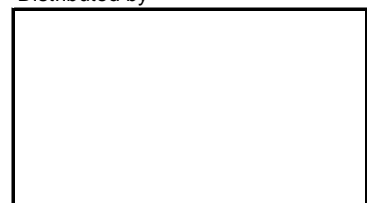

All the characteristics given in this data sheet are guaranteed only with uniform clamping force, cleaned and lubricated heatsink, surfaces with flatness < .03 mm and roughness < 2 μ m. In the interest of product improvement POSEICO SpA reserves the right to change any data given in this data sheet at any time without previous notice. If not stated otherwise the maximum value of ratings (symbols over shaded background) and characteristics is reported.